



# Neighborhood Traffic Management Program Traffic Calming Guidelines (2021 Update)

June 2021

**Prepared for:** City of Stockton Public Works Department

**Prepared by:** FEHR & PEERS



OC17-0532.01

# Table of Contents

---

<b>Introduction.....</b>	<b>1</b>
Purpose .....	1
Goals.....	2
How the Guidelines were Developed.....	2
For More Information.....	3
<b>Neighborhood Traffic Management Program (for Existing Neighborhoods).....</b>	<b>4</b>
Process for Selecting a Neighborhood .....	4
Getting the Process Started .....	5
Timeframe .....	5
Traffic Calming Plan: .....	5
Developing the Plan .....	7
Voting Process .....	7
<b>Existing Neighborhood Implementation.....</b>	<b>8</b>
1. Characterizing the Problem and Its Environment .....	8
Neighborhood Input .....	8
Characterizing Problem Details.....	8
Collecting Data .....	9
2. Setting Goals.....	9
3. Choosing the Process (Full Program or Expedited Program) and the Traffic Calming Committee.....	9
4. Selecting Measures .....	9
Selecting Measures for the Problem Type.....	9
Selecting Measures for the Location Type .....	10
Selecting Measures for the Street Environment.....	10
5. Placing the Traffic Calming Measures.....	13
<b>New Neighborhood Implementation.....</b>	<b>15</b>
Designing Street Networks .....	15
Designing for Appropriate Speeds .....	16
Designing for Local Traffic.....	17
Pedestrian/Vehicle Conflict Areas .....	17
Developing a Traffic Calming Plan .....	17
<b>Toolbox of Traffic Calming Measures.....</b>	<b>19</b>

Non-Physical Measures .....	19
Description .....	19
TARGETED SPEED ENFORCEMENT .....	20
RADAR TRAILER.....	20
SPEED FEEDBACK SIGNS.....	21
LANE STRIPING .....	21
APPROVED MARKINGS PER MUTCD .....	22
SIGNAGE.....	22
BOTTS DOTS AND RAISED REFLECTORS.....	23
HIGH-VISIBILITY CROSSWALK .....	23
Narrowing Devices .....	24
Description .....	24
BULBOUTS .....	24
TWO-LANE CHOKER.....	25
CENTER ISLAND NARROWING/PEDESTRIAN REFUGE ISLAND.....	26
Horizontal Deflection Devices.....	27
Description .....	27
TRAFFIC CIRCLE .....	28
ROUNDBOUT (per FHWA-SA-15-074/City Standard).....	29
CHICANE .....	30
Vertical Deflection Devices.....	31
Description .....	31
SPEED HUMP .....	32
SPEED CUSHION .....	33
SPEED TABLE.....	34
RAISED CROSSWALK .....	35
RAISED INTERSECTION.....	36
Diversion Devices .....	37
Description .....	37
FULL CLOSURE .....	38
HALF CLOSURE .....	39
MEDIAN BARRIER .....	40
FORCED-TURN ISLAND .....	41
Effectiveness Comparison.....	42
<b>Design Guidelines.....</b>	<b>43</b>

Emergency Response Routes .....	43
Horizontal Deflection Measures.....	43
Traffic Circle Placement.....	43
Traffic Circle Center Island Profile.....	43
Traffic Circle Turn Operations.....	43
Traffic Circles at T-Intersections.....	43
Signing & Marking .....	44
Combined Measures.....	44
Roundabouts .....	44
Vertical Deflection Measures – Humps and Cushions Installation.....	46
Selection of Precise Installation Locations.....	46
Signs and Markings.....	46
<b>References.....</b>	<b>48</b>

## Appendices

---

Appendix A: Standard Traffic Calming Device Designs

Appendix B: Checking Roundabout Compatibility

## List of Figures

---

Figure A-1. NTMP Process Flowchart .....	6
Figure A-2: Triple 4 Crosswalk .....	51
Figure A-3: Traffic Circle .....	52
Figure A-4: Chicane .....	53
Figure A-5: Bulbout (Midblock Treatment) .....	54
Figure A-6: Bulbout (Intersection Treatment) .....	55
Figure A-7: Center Island Narrowing .....	56
Figure A-8: Choker .....	57
Figure A-9: Speed Table .....	58
Figure A-10: Raised Crosswalk .....	61
Figure A-11: Raised Intersection .....	62
Figure A-12: Half Closure .....	63
Figure A-13: Median Barrier .....	64
Figure A-14: Forced Turn Island .....	65
Figure A-15: Warning Signs .....	66
Figure B-1. Approach Capacity of an Urban Single-Lane Roundabout .....	71

## List of Tables

---

Table 1 – Traffic Calming Measures and Problem Types .....	11
Table 2 – Traffic Calming Measures and Location Types .....	12
Table 3 – Traffic Calming Measures and Traffic Constraints .....	14
Table 4 – Quantitative Impacts of Traffic Calming Measures .....	42

*This page intentionally left blank.*

# Introduction

## Purpose

The City of Stockton developed a Neighborhood Traffic Management Program (NTMP) to address concerns about safety, noise and quality of life issues related to vehicle traffic on neighborhood streets. The NTMP includes a formal process for the implementation of traffic calming measures in Stockton neighborhoods and a toolbox of potential traffic calming measures. This document outlines the traffic calming program and is supported by two related documents:

- Street Design Guidelines, which include revisions to Stockton’s street development standards to include narrower street widths, landscape strips separating the curb from the sidewalk, and requirements for roundabouts and traffic circles in lieu of traffic signals or stop signs at many new intersections as development occurs in Stockton
- Pedestrian Safety and Crosswalk Installation Guidelines, which provide guidance for improving pedestrian safety, circulation, and specific guidelines for the installation of crosswalks

The traffic Calming Guidelines provide a framework for the selection, application, and design of traffic calming measures in the City of Stockton. This document is primarily intended for use by City staff and neighborhood residents when developing traffic calming plans as part of the NTMP. The NTMP is the formal process by which City staff identifies neighborhoods in need of traffic calming and implements a neighborhood specific traffic calming plan to reduce the severity of the problem at hand. This document also assists City staff and developers concerned with avoiding traffic problems in new neighborhoods and members of the general public who are interested in finding out how the City of Stockton implements traffic calming plans.

Being guidelines, the contents are not intended as rigid requirements; rather, they are a tool for use by City staff, citizens, and other interested parties to help develop effective traffic calming plans that adequately accommodate motor vehicles, pedestrians, and bicyclists, while enhancing the neighborhood environment.

The guidelines provide a process for City staff and community members to identify various traffic calming problems experienced in existing neighborhoods (i.e. high speeds, volumes, and cut-through traffic) and to develop effective solutions. A “toolbox” of traffic calming measures describes each device and the type of problem that it is effective at treating. The toolbox also contains pictures of past installations, design considerations that may apply to your preferred traffic calming solutions, and design standards.

City Staff and developers can reduce the need for future traffic calming by designing new streets that discourage speeding and cut-through traffic. Streets should be designed to provide adequate travel lanes and parking yet avoid excessive widths. Shorter blocks reduce the ability of drivers to reach and maintain

high speeds. To supplement these good design practices, traffic calming measures can also be installed as part of the initial development.

Modifications to the NTMP Guidelines may be incorporated and approved by the NTMP Manager and the City Traffic Engineer. The NTMP Manager and the City Traffic Engineer also have the authority to make final determinations when processing neighborhoods for traffic calming.

## Goals

The goal and objectives of this document are patterned after the NTMP. The driving goal of the NTMP is:

To improve safety and the quality-of-life for residents by reducing the impacts from speeding vehicles, cut-thru traffic, and careless drivers.

The NTMP strives to meet this goal through the implementation of self-enforcing mechanisms that result in:

- Reduced speeding
- Reduced numbers and/or reduced severity of reported collisions
- Reduced cut-through traffic where existing levels are significant and where the remedy will not create a problem on other streets
- A better environment for residents and business owners as indicated by their sense of safety, property values, comfort in using the street, and reduced traffic-related complaints

These objectives will be met through effective engineering principles applied to the development of traffic calming strategies that address community-identified traffic issues. Residents will be educated with information and tools necessary to become active participants in addressing their neighborhood traffic concerns. Targeted police enforcement will support the traffic calming plan developed by residents and the City Traffic Engineer.

The traffic calming measures proposed in this document are intended for use on two-lane local residential, local commercial, and minor collector streets to "calm" traffic in and around neighborhoods. Speed management on arterials and major collectors can be accomplished through non-physical measures (such as signal timing) rather than physical devices that reduce roadway capacity.

The role of the guidelines in supporting the goal and objectives above is to articulate the method by which tools and strategies are considered and selected for use in meeting those goals and objectives.

## How the Guidelines were Developed

The contents of the guidelines were developed with the assistance of an advisory panel, composed of City staff and other local agencies. The advisory panel was convened on January 24, 2003, for a workshop designed to gather input on the traffic calming guidelines.



The workshop also included a tutorial on traffic calming, focusing on the types of measures available including engineering and aesthetic issues. The panel actively discussed traffic calming measures and aesthetic options. Through this discussion, the panel reached a consensus that defined the range of acceptable roadway characteristics on which selected measures, designs, and aesthetics would be applicable.

In June 2006, these guidelines were revised to reflect changes approved by the City Council such as the way neighborhoods are organized on the waiting list and the inclusion at vertical traffic calming measures in the “toolbox.”

These guidelines were revised again in April 2008 to simplify the overall process in order to shorten its timeline and reduce administrative costs. Part of this revision included creating an Expedited Program that allowed only a few choices from the “toolbox” but provided an expedited process.

Traffic calming measures, including speed humps and speed cushions, located within the City of Stockton rights-of-way are subject to removal if the City identifies a public safety concern, improper installation, change in the regulatory context, or change in the environment (such as new development or new streets). The City shall be financially responsible for the removal of traffic calming devices.

## For More Information

The guidelines draw extensively from the approved *City of Sacramento Traffic Calming Guidelines*, 2002 and two documents written by Reid Ewing: *Traffic Calming: State of the Practice* (Reid Ewing, FHWA, 1999) and *Delaware Traffic Calming Design Manual* (Reid Ewing, Delaware Department of Transportation, 2000). More recently, these guidelines have been updated pursuant to the FHWA Traffic Calming e-Primer Module 3 (July 9, 2019)<sup>1</sup> and the U.S. Traffic Calming Manual (Reid Ewing and Steven J. Brown, 2009). For more detailed information on the topics addressed in this document, please refer to these reports. A more comprehensive list of resources is listed in Chapter VII.

---

<sup>1</sup> FHWA e-Primer – Module 3 was accessed online on September 24, 2020 at: [https://safety.fhwa.dot.gov/speedmgt/ePrimer\\_modules/module3.cfm](https://safety.fhwa.dot.gov/speedmgt/ePrimer_modules/module3.cfm)

## Original Advisory Panel Members

- Jim Giottonini, City of Stockton Public Works Department
- Todd Greenwood, City of Stockton Public Works Department
- Nate Knodt, San Joaquin Regional Transit District
- Victor Machado, City of Stockton Parks & Recreation
- Gregg Meissner, City of Stockton Public Works Department
- Michael Morrell, City of Stockton Fire Department
- Barry O’ Regan, City of Stockton Public Works Department
- Dianne Smith, City of Stockton Planning Department
- Gary Tsutsumi, City of Stockton Public Works Department
- Tom Wells, City of Stockton Police Department
- Kari Wilson, San Joaquin Regional Transit District

# Neighborhood Traffic Management Program (for Existing Neighborhoods)

## Process for Selecting a Neighborhood

For a neighborhood to be included in the NTMP, a resident must complete the NTMP Request Form which includes questions about the neighborhood boundaries, traffic issues that concern residents in the neighborhood, and a petition. Ten residents at least 18 years of age and from separate households within the neighborhood boundaries described in the NTMP Request Form must sign the petition. The completed form/petition must be submitted to the Public Works Department, Traffic Engineering/NTMP.



The process began with an initial sixty-day filing period to provide an equal opportunity for all interested residents to submit their completed form. At the close of the filing period, a lottery was held to determine the order of participation and establish a waiting list. Public Works continuously accepts NTMP Request Forms and adds requests to the waiting list in the order received. The goal is to select the next two to four neighborhoods wait-listed in each of four geographical areas to participate in the program each year. A total of 8 to 16 neighborhoods will be selected each year. The Calaveras River divides the north and south areas, and Lower Sacramento Road, Pacific Avenue, Harding Way, and El Dorado Street divide the east and west areas.

Neighborhood boundaries will be established based on information from the NTMP Request Form, a review by Public Works staff to ensure that all affected areas are included, and input from the City Council if necessary. Requests with overlapping boundaries may be consolidated if appropriate. The NTMP process is summarized by the flowchart in Figure A-1.

The process includes two program options – the Expedited Program and the Full Program. The Expedited Program is an expedited process that includes the use of only vertical measures, such as speed humps/cushions/tables, striping, and signing while the Full Program allows the use of all the traffic calming options in the “toolbox”. At the beginning of the process, the neighborhood will need to decide which program they want to pursue. However, nothing precludes a neighborhood from changing programs during the process, prior to hiring a consultant, if they so choose.

## Getting the Process Started

Public Works kicks off the NTMP in each selected area by inviting all residents to learn more about the program at a community meeting. At this meeting, interested residents can volunteer to participate on the Traffic Calming Committee (TCC) for their neighborhood. Although all residents provide input and receive updates as the plan develops, the TCC is more actively involved, committing the time and effort necessary to develop a comprehensive plan.

## Timeframe

The approximate timeline for each program is shown in Figure A-1. The timelines for each program are approximate and depend on the number of meetings that the neighborhood needs to develop and approve a traffic calming plan.

## Traffic Calming Plan:

All neighborhoods begin by developing a traffic calming plan aimed at changing driver behavior. Under the Expedited Program the traffic calming plan will use non-physical and vertical measures, including humps and cushions. The Full Program will have the option of choosing from all five types of traffic calming measures as follows:

- Non-physical measures – include reducing obstructions that limit driver visibility, signage, and striping improvements
- Narrowing measures – include bulbouts, chokers, and center island narrowing
- Horizontal measures - include traffic circles, roundabouts, and chicanes
- Vertical measures – include speed humps and speed cushions
- Diversion Devices – includes partial and full street closures

These measures are in addition to typical police enforcement. With installation of any measure, the City will direct additional police enforcement resources to the area for a few weeks – reinforcing desired driver behavior.

Non-Physical Measures (i.e. visibility, signage and striping improvements, etc.) do not require the same level of community consensus as the implementation of physical measures. Therefore, Non-Physical Measures (see Table 1) may be installed with a request from the TCC and approval by the City Traffic Engineer.

Figure A-1. NTMP Process Flowchart

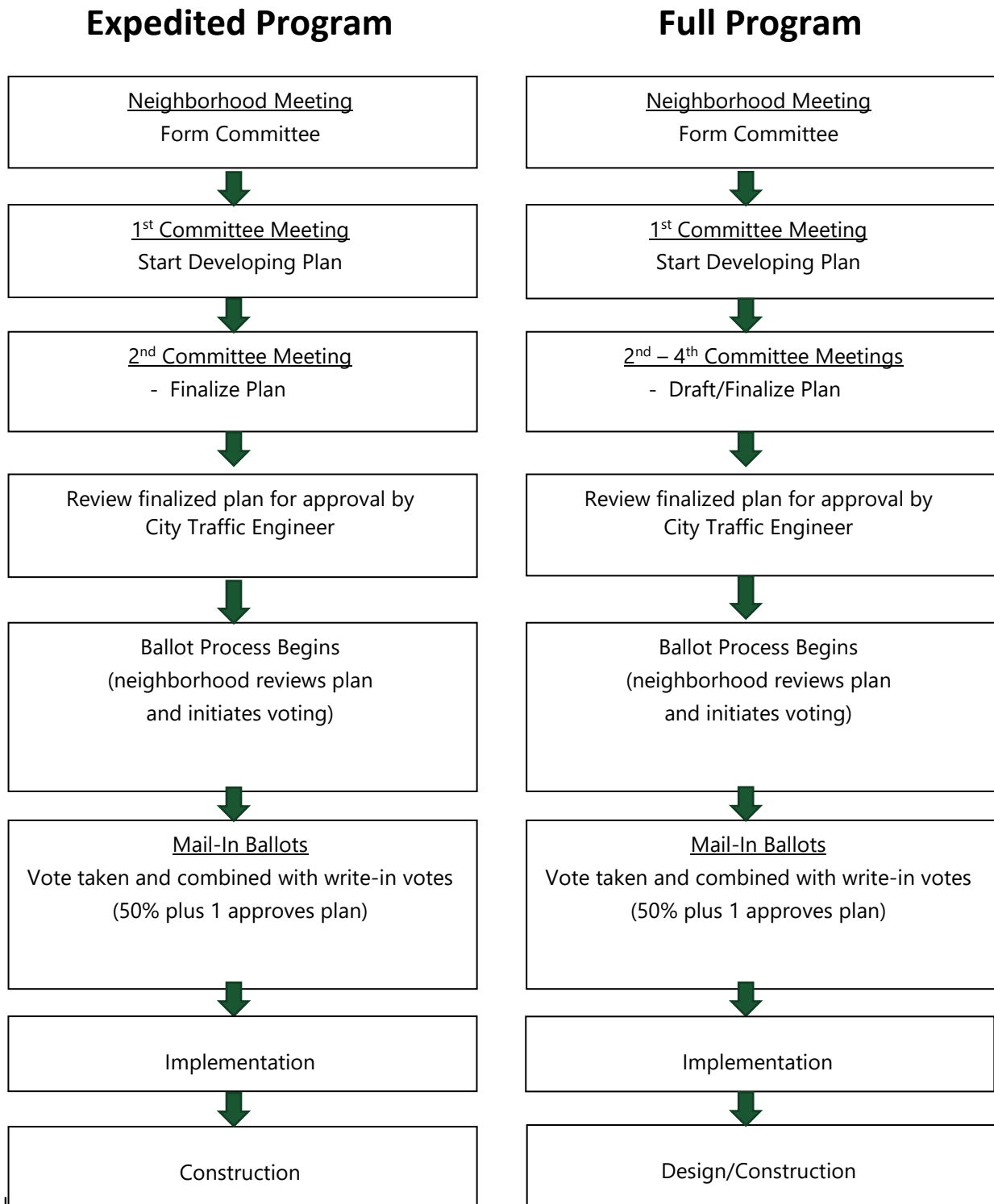

## \* Schedule dependent on number of Committee Meetings

### Developing the Plan

The TCC and Public Works hold regular meetings to

- Organize neighborhood outreach
- Identify specific traffic concerns
- Target potential measures
- Consider transit needs and public safety, if applicable
- Develop a traffic calming plan

### Voting Process

All neighborhood households and businesses have the opportunity to participate in a vote to approve the traffic calming plan that is developed. A simple majority of those that chose to vote is needed to approve the plan. Every household and business is allowed one vote.

*For a neighborhood approved plan developed through the Full Program process, design plans, specifications, and estimates will be prepared and the project advertised for bids. The plan is then presented to the City Council for final approval, funding, and award of a construction contract.*

For a neighborhood approved plan developed through the Expedited Program process, no design work will be needed. City staff will provide updates to the representative councilmember throughout the process. Once this type of plan is approved by a neighborhood vote, City staff will proceed straight to construction.

# Existing Neighborhood Implementation

This chapter addresses how to select a traffic calming device in an existing neighborhood. Typically, this process will occur as a part of the larger NTMP. By clearly identifying traffic problems, setting goals and selecting appropriate traffic calming measures to meet those goals, the City can develop a traffic calming plan that has a greater likelihood of being approved and of meeting its goals. The following steps describe the process for implementing traffic calming measures.

## 1. Characterizing the Problem and Its Environment

The first step in developing a traffic calming plan is to characterize the problem type and to gather information about other conditions present at the problem location. This is accomplished through two tasks:

- Gathering neighborhood input on problems and priorities
- Characterizing problem details

### Neighborhood Input

Resident input must be used to determine whether the primary concern is one of vehicle safety, pedestrian safety, congestion, noise, inconvenience, or something else entirely. If speeding is raised as the main issue, it is important to determine whether the noise factor, the safety factor, or some other concern is paramount. If cut-through traffic is a concern, it is important to know why the traffic is problematic: does it travel too fast, or is there simply such a high volume that it bogs down traffic flow through the neighborhood? If safety is the main concern, then what seems to be the cause: high speeds, cut-corners, or a particularly dangerous conflict location? In many cases, a problem that initially looks like a speeding problem may be a safety problem, or one that initially looks like a volume problem may be a speeding problem.

### Characterizing Problem Details

When the primary problem type is determined, the details of the problem need to be characterized: exactly where does it occur, and at what times of day and days of week? Is there a traffic control device (such as all-way stop control at an intersection) that does not seem to work?

### Types of Traffic Data

- **Roadway Geometry:** Street widths, block lengths, and locations of stop signs and traffic signals.
- **Roadway Users:** Traffic volumes during peak hours, the entire day, and any particular periods when the problem occurs; pedestrian and bicycle volumes; truck volumes; bus routes; designation as a primary emergency response route; and origin-destination studies.
- **Vehicle Performance Data:** travel speeds, stop sign violations, rates of unsafe driving practices (e.g. cutting corners or crossing the centerline), and collision records.

## Collecting Data

Knowing the exact nature of the problem, the next step is to collect relevant information about the problem and its environment. See the sidebar “Types of Traffic Data” for some examples. For the Expedited Program, data collection will be minimal.

## 2. Setting Goals

Before selecting either the Full Program or the Expedited Program, the neighborhood should have some idea of their desired outcome. Goals should be stated to express the results that the neighborhood would like to achieve with a Traffic Calming Plan.

## 3. Choosing the Process (Full Program or Expedited Program) and the Traffic Calming Committee

At the first Neighborhood meeting, a decision must be made as to which program will be selected – Full Program or the Expedited Program. This choice will have an effect on the types of devices that may be used in a Traffic Calming Plan and the speed at which these devices are in place.

As noted previously, the Expedited Program is a much faster process, however, the types of traffic control devices are limited to vertical measures, signage and striping.

The Full Program has the advantage of allowing a much broader range of control devices but will take longer to work through and, ultimately, to construct.

The program selection is not final and irrevocable. A neighborhood can choose to change the program selected during the process.

Once the neighborhood selects the program, a Traffic Calming Committee (TCC) must be formed with approximately six to ten volunteers from the neighborhood that can be actively involved and commit the time needed to develop a draft Traffic Calming Plan. This draft Plan must then be approved by the neighborhood via a vote before it is implemented.

## 4. Selecting Measures

In either program, the next step is to determine which traffic calming measures will be used at specific locations.

### Selecting Measures for the Problem Type

The major types of problems that result in a desire for traffic calming include:

- **Speeding** – motor vehicle speeds (measured by the 85<sup>th</sup> percentile) consistently exceed the posted speed limit by ten (10) or more miles per hour.

- **Traffic Volumes** – motor vehicle usage levels (all trips or non-local trips only) are too high in the context of adjacent land uses and/or pedestrian and bicycle activity.
- **Vehicle Safety** – examples include limited sight distance and/or inadequate striping and signage
- **Pedestrian Safety** – motor vehicles cause an unnecessary risk to pedestrians as reflected in available data.
- **Noise/Vibration/Air Pollution** – motor vehicles cause excessive levels of these environmental effects

Each device in the toolbox is appropriate to a different subset of the above problem types. The appropriateness of each device is summarized in Table 1 (page 11).

### Selecting Measures for the Location Type

Identification of appropriate traffic calming measures should start by determining which measures are applicable to the location of the problem. If the traffic problem is confined to a specific roadway segment, then only measures applicable to roadway segments can be considered. Some other measures can be considered at intersections. Furthermore, certain types of devices are appropriate in residential areas but not in non-residential areas. Table 2 (page 12) indicates the location(s) where each traffic calming measure is applicable.

### Selecting Measures for the Street Environment

The last step in narrowing the field of devices requires finding which devices are compatible with the traffic volumes, posted speeds, and roadway users at the proposed location. For example, many devices have an upper boundary of traffic volumes beyond which any greater volume could result in traffic congestion that might be perceived as worse than the original traffic problem.

Also, since most devices cause some delay for emergency vehicles and transit buses, only certain devices can be used on primary emergency response routes and transit routes. Some measures have additional restrictions, such as hills, curves and bicycle routes that must be considered.

Table 3 (page 14) summarizes the constraints on the use of traffic calming devices in these various environments.



**Table 1 – Traffic Calming Measures and Problem Types**

Types of Measures		Type of Problem					
		Speeding	Traffic Volume	Vehicle Accidents	Pedestrian Safety	Noise	
<b>Non-Physical Measures</b>							
	Targeted Speed Enforcement	●	○	◐	◐	◐	
	Radar Trailer	●	○	○	○	◐	
	Speed Feedback Signs	●	○	○	○	◐	
	Edgeline/Centerline Striping	●	○	○	○	○	
	Speed Limit Signage	●	○	○	○	○	
	Truck Restriction Signs	○	◐	○	○	●	
	"Cross Traffic Does Not Stop" Signage	○	○	●	◐	○	
	Botts Dots/Raised Reflectors	○	○	●	◐	○	
	High-Visibility Crosswalks	◐	○	○	●	○	
<b>NARROWING MEASURES</b>							
	Bulbouts	●	◐	○	●	○	
	Two-Lane Chokers	●	◐	○	○	○	
	Center Island Narrowing/ Pedestrian Refuges	●	◐	◐	●	○	
<b>Horizontal Measures</b>							
	Traffic Circles	●	◐	●	◐	○	
	Roundabouts (Single-Lane)	◐	◐	●	○	●	
	Lateral Shifts	◐	◐	○	○	○	
	Chicanes	●	◐	○	○	○	
<b>Vertical Measures</b>							
	Speed Humps	●	●	◐	◐	×	
	Speed Cushion	●	●	◐	◐	×	
	Speed Tables	●	◐	◐	◐	×	
	Raised Crosswalks	●	◐	◐	●	×	
	Raised Intersections	●	◐	◐	●	×	
	Textured Pavement	◐	○	○	◐	×	
<b>Diversion Devices</b>							
	Full Closures	●	●	○	○	○	
	Half Closures	●	●	○	○	○	
	Diagonal Diverters	●	●	○	○	○	
	Median Barriers	○	●	◐	○	○	
	Forced Turn Islands	○	●	◐	○	○	
Key:	● = Strongly Appropriate		×				Inappropriate/Counterproductive
	◐ = Moderately Appropriate		○				Indifferent

**Table 2 – Traffic Calming Measures and Location Types**

Types of Measures		Residential			Non-Residential	
		Midblock	Intersection	Boundary of Area	Midblock	Intersection
<b>Non-Physical Measures</b>						
	Targeted Speed Enforcement	●	●	●	●	●
	Radar Trailer					
	Speed Feedback Signs					
	Edgeline/Centerline Striping	●	×	×	●	×
	Speed Limit Signage	●	●	●	●	●
	Truck Restriction Signs	×	×	●	×	●
	"Cross Traffic Does Not Stop" Signage	×	○	●	×	○
	Botts Dots/Raised Reflectors	<b>On Curves</b>	×	×	●	×
	High-Visibility Crosswalks	●	<b>Unsignalized Intersections</b>	<b>Unsignalized Intersections</b>	●	<b>Unsignalized Intersections</b>
	<b>Narrowing Measures</b>					
	Bulbouts	×	●	●	×	●
	Two-Lane Chokers	●	×	×	●	×
	Center Island Narrowing/ Pedestrian Refuges	●	●	●	●	●
<b>Horizontal Measures</b>						
	Traffic Circles	×	●	○	×	○
	Roundabouts (Single-Lane)	×	○	○	×	●
	Lateral Shifts	●	×	×	●	×
	Chicanes					
<b>Vertical Measures</b>						
	Speed Humps	●	×	×	×	×
	Speed Cushions					
	Speed Tables	●	×	×	○	×
	Raised Crosswalks	●	○	○	○	×
	Raised Intersections	×	●	●	×	●
	Textured Pavement	●	●	●	●	●
<b>Diversion Devices</b>						
	Full Closures	×	●	●	×	×
	Half Closures	×	●	●	×	×
	Diagonal Diverters	×	●	×	×	×
	Median Barriers	×	○	●	×	×
	Forced Turn Islands	×	○	●	×	●
Key:    × = Seldom or never applicable.                      ● = Generally applicable. ○ = Not applicable except in some cases.						

**Non-Physical Measures** – The first solutions to consider should always be the Non-Physical Measures, such as signs and markings, since these can be most easily removed if unanticipated problems occur.

**Narrowing Devices** – The next type of traffic calming measure to consider should be Narrowing Measures, such as bulbouts or center island medians, which are less obtrusive and more aesthetically appealing than some other devices since they can be combined with landscaping.

**Horizontal Deflection Devices** – Narrowing Devices are followed by Horizontal Deflection Devices, such as chicanes and traffic circles, which are more intrusive but also more effective because they force vehicles to navigate horizontally around physical objects. These can also be combined with landscaping.

**Vertical Deflection Devices** – Vertical deflection devices such as a speed humps or speed cushions are generally the most effective at reducing travel speeds, but they can also be controversial because of driver discomfort, noise, and aesthetics.

**Diversion Devices** – Diversion devices include half or full road closures and forced turn islands. Installation of these devices is not appropriate if they simply move the traffic issue to an adjacent street.

## 5. Placing the Traffic Calming Measures

The last task in laying out a traffic calming plan is to identify the actual locations where devices should be placed. Strategies for location devices differ depending on whether the major issue is speed-control, volume-control, or safety. Refer to Tables 1, 2, and 3 for guidance.

**Table 3 – Traffic Calming Measures and Traffic Constraints**

Types of Measures	Roadway Classification		Bus or Emergency Response Route	Other Considerations
	Local Streets	Residential Collectors		
<b>Non-Physical Measures<sup>1</sup></b>				
Targeted Speed Enforcement	ADT < 10,000; Speed Limit ≤ 35 mph		OK	(None)
Radar Trailers				
Speed Feedback Signs				
Edgeline/Centerline Striping				
Signage				
Center Line or Edge Line Botts Dots				
High Visibility Crosswalk				
<b>Narrowing Measures<sup>1</sup></b>				
Bulbouts	ADT < 20,000; Speed Limit ≤ 35 mph		OK	On bike routes, design with clear bike accommodations
Two-Lane Chokers	ADT < 20,000; Speed Limit ≤ 35 mph		OK	
Center Island Narrowing/Pedestrian Refuge	ADT < 20,000; Speed Limit ≤ 35 mph		OK	
<b>Horizontal Measures<sup>1</sup></b>				
Traffic Circles	Daily Entering Volume < 7,500; Speed Limit ≤ 35 mph	May be required at intersections where residential collector streets intersect with local streets	OK	Grade ≤ 10%
Roundabouts (Single-Lane)	Daily Entering Volume < 20,000; Speed Limit ≤ 45 mph		Must design inscribed radius to be 100+ feet	Grade ≤ 6%; On bike routes, design with clear bike accommodations
Lateral Shifts	ADT < 10,000; Speed Limit ≤ 35 mph		OK	Grade ≤ 10%
Chicanes	ADT < 5,000; Speed Limit ≤ 35 mph			Grade ≤ 8%
<b>Vertical Measures<sup>1</sup></b>				
Speed Humps	ADT < 4,000; Speed Limit ≤ 30 mph		NO	Grade ≤ 8%
Speed Cushions			OK	
Speed Tables	ADT < 7,500; Speed Limit ≤ 35 mph		OK	
Raised Crosswalks			OK	
Raised Intersections			OK	
Textured Pavement	Yes		OK	
<b>Diversion Devices<sup>2</sup></b>				
Full Closures	ADT < 5,000 >25% Non-Local Traffic	No	No	None
Half Closures and Diagonal Diverters			PW review	
Median Barriers and Forced Turn Islands		ADT < 5,000 >25% Non-Local Traffic	No	
			No	

Notes:

<sup>1</sup> Traffic calming devices are suitable for existing and new streets.

<sup>2</sup> Not to be used on new streets.

<sup>3</sup> San Joaquin Regional Transit District.

# New Neighborhood Implementation

In addition to existing neighborhoods, new neighborhoods in the planning stage can benefit from neighborhood traffic management. As part of the NTMP, the City has recently developed Draft Street Design Guidelines that include revisions to the City's design standards for new streets. A key element of the revisions is the development of narrower local and collector street standards, and shorter block lengths, to slow and disperse traffic.

Traffic problems can often be anticipated and prevented by properly reviewing street and lot plans for a neighborhood and prescribing refinements to the plan or identifying traffic calming measures that can be constructed concurrent with street construction. The process for reviewing new residential subdivisions is as follows:

1. **Development Services Review** – Prior to final approval of a street and lot plan, the plan will be reviewed by the City's Development Review Committee (DRC). In this review, staff will identify proposed roadway layout features that are likely to cause traffic problems, such as inducing speeding or cut-through traffic or presenting an unnecessary risk of collisions.
2. **Traffic Engineering Review** – The City's Traffic Engineering Section will review the above recommendations. Any discrepancies will be discussed and resolved.
3. **Plan Revisions** – Development Services staff will submit the final comments on the street layout to the developer. If the indicated roadway changes are infeasible due to other constraints, then City Development Services will prescribe traffic calming measures based on the guidelines contained in this document. The cost of the traffic calming measures will be borne by the developer.
4. **SJRTD Review** – SJRTD will review the plans to determine the need for future bus routes in the new development and placement of bus stops and associated transit amenities (benches or shelters). The cost of bus stop installation and transit amenities will be borne by the developer.

## Designing Street Networks

The guidelines below describe some common street design features and their propensity to lead to traffic calming problems such as speeding and cut-through traffic. These guidelines are intended to complement the Street Design Guidelines. They should also assist developers in laying out streets in new residential developments and City staff in reviewing them pursuant to the process described above. This chapter is by no means comprehensive on the layout of new residential streets. For detailed information, the following documents are recommended:

- [City of Stockton Street Design Guidelines](#), City of Stockton, 2013
- [Residential Street Design and Traffic Control](#), Homburger, Deakin, Bosselmann, Smith, and Beukers (Institute of Transportation Engineers), 1989
- [Residential Streets](#), American Society of Civil Engineers, National Association of Home Builders, and the Urban Land Institute, 1990

- Traditional Neighborhood Development: Street Design Guidelines, Institute of Transportation Engineers, 1999

## Designing for Appropriate Speeds

The following paragraph from *Residential Streets* (ASCE/NAHB/ULI, 1990) provides a useful summary of the task of designing residential streets to minimize speeding problems:

“The selection of appropriate pavement widths must account for probable peak traffic volume, parking needs and controls, likely vehicle speeds, and limitations imposed by sight distances, climate, terrain, and maintenance requirements. Designers should select the *minimum* width that will reasonably satisfy all realistic needs, thereby minimizing construction and average annual maintenance costs. The tendency of many communities to equate wider streets with better streets and to design traffic and parking lanes as though the street were a “microfreeway” is a highly questionable practice. Certainly the provision of 11- or 12-foot clear traffic lanes is an open invitation to increased traffic speeds.”

*Residential Streets* goes on to recommend pavement widths for access streets, sub-collectors, and collector streets. In addition to wide streets, long, straight, and uninterrupted stretches of residential roadways can also induce drivers to accelerate to unsafe speeds, increasing noise and risk of accidents with pedestrians and other vehicles. The following attributes should be considered when designing residential streets.

- **Travel Lane Width** – Travel lanes are often designed with excessive widths. To minimize drivers’ propensity to speed, residential travel lanes on local streets should be designed to be no more than 10 feet wide. Wide shoulders should not be included unless they are needed to accommodate demand for parking or are striped as bicycle lanes. If excess width is provided in anticipation of a future need for traffic capacity, then in the short-term this width should be occupied by appropriately spaced chokers or other traffic calming measures (see Chapter II).
- **Parking Lanes** – Excessive width is sometimes provided for on-street parking in places where adjacent land uses generate little parking demand, leaving long gaps of unused space adjacent to the travel lane. This can often be the case along residential collector streets with few front-on houses. If the parking demand can be accommodated elsewhere, the parking lanes should be eliminated and the street width reduced accordingly.
- **Block Length** – Some street networks leave excessively long blocks without interrupting intersections. Drivers that travel a long distance (600 feet or greater) without being required to slow or stop by traffic control or traffic calming devices tend to travel at speeds higher than the limit. To minimize this effect, the street network can be designed such that street blocks are interrupted by streets of sufficient traffic volumes to warrant a traffic control device (e.g. a traffic circle or stop sign) on the street of concern. Shorter block lengths also facilitate pedestrian

movement throughout the neighborhood. Acceptable block lengths for low and medium volume residential streets should not exceed 600 and 800 feet respectively, while collector street block lengths should not exceed 1,000 feet.<sup>2</sup>

## Designing for Local Traffic

If designed improperly, some residential collector streets can become cut-through routes, or routes used by non-local motorists as a means of bypassing congested or circuitous arterial roads. In these cases, the residential collector should be modified in one of two ways.

- The collector can be designed with a deviating path so that the overall distance by collector is greater than the distance by arterial.
- The residential roadway network can be designed such that traffic-controlled intersections interrupt the parallel collector route sufficiently that the travel time by collector is greater than the travel time by arterial.

## Pedestrian/Vehicle Conflict Areas

Some elements of residential areas, such as schools and parks, have particularly high potential for vehicle and pedestrian conflicts because of the pedestrian activity they generate. The major pedestrian routes to school should be identified and traffic controls should be structured so that the number of crossings at uncontrolled cross-streets is minimized. For both schools and parks, entrances tend to focus pedestrian street crossings at particular locations. These entrances can be made safer by combining them with roadway intersections, so that the intersection's traffic control can also allocate right-of-way to pedestrians.

If a pedestrian-oriented land use is located in an area where speeding or high traffic volumes are unavoidable, then traffic calming measures should be selected that incorporate pedestrian accommodations. For example, at an intersection, bulbouts or center island narrowing should be given some preference over other measures, such as intersection realignment. Midblock locations can benefit from such treatments as chokers or chicanes.

## Developing a Traffic Calming Plan

When a proposed street layout cannot be modified in such a way that will eliminate all potential traffic problems, a traffic calming plan should be developed. The procedure for developing a traffic calming plan should be the one described in Chapter II, with the following exceptions:

- For volume-related problems, traffic volume data will only be available in the form of traffic forecasts, and these will typically be limited to the major roads. Some manual traffic volume estimates may be required using land use quantities and trip generation rates for the proposed development.

---

<sup>2</sup> City of Stockton Street Design Manual, 2003.

- For speed-related problems, existing travel speed data will not be available. Consequently, a response to anticipated speeding problems would need to rely on roadway geometry. For example, if a block length is greater than 600 feet, then traffic calming measures could be used to break up the block into segments that are each shorter than 600 feet.
- Anticipated safety problems will likely revolve around land uses that generate pedestrian activity, such as schools, parks, and community centers. The placement of traffic calming devices that include pedestrian crossings should take into consideration the planned locations of walkways, gates, and building entrances for these land uses.
- For some traffic calming measures, particularly those involving modified roadway curbs, significant cost-savings can be achieved by constructing them concurrent with roadway construction. Consequently, when selecting a type of traffic calming measure, some additional preference should be given to measures that take advantage of these cost-savings.



# Toolbox of Traffic Calming Measures

The following traffic calming measures constitute the standard “toolbox” of devices available to citizens and Public Works staff when developing neighborhood traffic management plans:

- Non-Physical Measures
- Narrowing Measures
- Horizontal Deflection Measures
- Vertical Deflection Measures
- Diversion Measures

For each non-physical and physical measure in the toolbox, a description, photograph, and a list of advantages and disadvantages are provided. In addition, all physical traffic calming measures include an overhead schematic and detailed standard designs which are located in Appendix A.

## Non-Physical Measures

### Description

Non-physical measures include any measures that do not require the construction of physical modifications to the roadway. This category includes signing and striping modifications, as well as temporary use of certain enforcement strategies.

- **Targeted Speed Enforcement**
- **Radar Trailers**
- **Speed Feedback Signs**
- **Lane Striping**
- **Approved Markings per current MUTCD**
- **Signage**
- **Centerline or Edgeline Botts Dots**
- **High Visibility Crosswalk**

## TARGETED SPEED ENFORCEMENT



The TCC identifies locations for temporary targeted enforcement enhancements, based on personal observations and survey comments.

A request is then submitted to the Police Department for the desired enforcement. Because of limited citywide resources, the targeted enforcement will not be continued indefinitely. Targeted enforcement may also be used in conjunction with new traffic calming devices to help drivers become aware of the new restrictions.

### Advantages

- Inexpensive if used temporarily
- Does not require time for design
- Does not slow trucks, buses, and emergency vehicles
- Effective in reducing speeds in a short time frame

### Disadvantages

- Expensive to maintain an increased level of enforcement
- Effectiveness may be temporary

## RADAR TRAILER



A radar trailer is a device that measures each approaching vehicle's speed and displays it next to the legal speed limit in clear view of the driver, reminding speeding drivers to slow to the speed limit. They can be easily placed on a street for a limited amount of time then relocated to another street, allowing a single device to be effective in many locations.

### Advantages

- Inexpensive if used temporarily
- Does not require time for design
- Does not slow emergency vehicles
- Effective in reducing speeds in the short-run

### Disadvantages

- Effectiveness may be temporary
- Aesthetics
- Only effective for one direction of travel
- Subject to vandalism

## SPEED FEEDBACK SIGNS

Speed feedback signs perform the same functions as radar trailers but are permanent. Real-time speeds are relayed to drivers and flash when speeds exceed the limit. Speed feedback signs are typically mounted on or near speed limit signs and can also be mobile units.



Source: City of Stockton (2020)

## LANE STRIPING

Lane striping can be used to create formal bicycle lanes, parking lanes, or simple edge lines. As a traffic calming measure, they are used to narrow the travel lanes for vehicles to encourage drivers to lower their speeds. The past evidence on speed reductions is, however, inconclusive.



Source: FHWA

### Advantages

- Inexpensive
- Does not require time for design
- Does not slow emergency vehicles
- Effective in reducing speeds in a short time frame

### Disadvantages

- Requires power source
- Only effective for one direction of travel
- Long-term effectiveness uncertain
- Subject to vandalism

### Advantages

- Inexpensive
- Can be used to create bicycle lanes or delineate on-street parking
- Does not require time for design
- Does not slow emergency vehicles

### Disadvantages

- Has not been shown to significantly reduce travel speeds
- Increases regular maintenance

## APPROVED MARKINGS PER MUTCD

The Manual of Traffic Control Devices provides several examples of pavement markings that can be used for traffic calming, such as edgelines, bike lane striping, pavement stencils, chevrons, and colored pavement to designate bike lanes. These features create driver awareness to the potential presence of non-automobile users.



Source: City of Stockton

## SIGNAGE

Signage that can be used as traffic calming measures include:

- Speed Limit Signs
- Truck Restriction Signs
- "Cross Traffic Does Not Stop" Signs

For speed limit signs to be eligible for radar enforcement, they must be set using an appropriate engineering and speed study.



Source: FHWA

## Advantages

- Inexpensive to install
- Reduction in 85<sup>th</sup> percentile speed
- Does not slow bus and emergency vehicles
- Does not require time for design

## Disadvantages

- Expensive to maintain
- Effectiveness diminishes after repeated use
- Aesthetics

## Advantages

- Inexpensive
- Does not require time for design
- Turn restrictions can reduce cut-through traffic
- Does not significantly slow emergency vehicles

## Disadvantages

- Speed limit signs are ineffective if unaccompanied by increased police enforcement
- If speed limit is set unreasonably low, drivers are more likely to exceed it

## BOTTS DOTS AND RAISED REFLECTORS

Botts dots and raised reflectors, or “raised pavement markers,” are small bumps lining the centerline or edgeline of a roadway. They are often used on curves where vehicles have a tendency to deviate outside of the proper lane, risking collision. Raised reflectors improve the nighttime visibility of the roadway edges.



Botts dots can be arranged into a rectangular array across the roadway, creating a *rumble strip*, which causes a rumbling sensation to drivers as they cross.

These can reduce travel speeds but also increase roadway noise considerably. Consequently, rumble strips are only placed in very low-density areas because of the noise factor.

## HIGH-VISIBILITY CROSSWALK

High-visibility crosswalks use special marking patterns and raised reflectors to increase the visibility of a crosswalk at night. A “triple-four” marking pattern is created by painting two rows of four-foot wide rectangles, separated by four feet of unpainted space across the roadway. Raised reflectors are placed at the approach edges of these rectangles. The unpainted space along the center of the crosswalk allows wheelchairs and foot traffic to cross in the rain without sliding problems across the paint.



Source: City of Stockton (2020)

## Advantages

- Increase visibility under low-visibility conditions
- Focus crossing pedestrians at a single location
- Motorists may not “tune out” IPFs as typical overhead beacons

## Disadvantages

- May give pedestrians a false sense of security
- Requires more maintenance than normal crosswalks
- Can decrease effectiveness of coordinated traffic signals

## Advantages

- Inexpensive
- Does not slow trucks, buses, and emergency vehicles
- Can help keep drivers in the appropriate travel lane on curves and under low-visibility conditions

## Disadvantages

- Noise caused by rumble strips may bother neighborhood residents

## Narrowing Devices<sup>3</sup>

### Description

Narrowing devices use raised islands and curb extensions to narrow the travel lane for motorists. The narrowing devices in the toolbox include:

- **Bulbouts**
- **Two-Lane Chokers**
- **Center Island Narrowings/Pedestrian Refuge Islands**

### BULBOUTS

Bulbouts (neckdowns, intersection narrowing, safe crosses, etc.) are curb extensions that reduce roadway width curb to curb at either midblock or intersection locations. Midblock treatments narrow the travel lane but do not provide additional sidewalk width. Intersection treatments actually “pedestrianize” intersections by shortening crossing distances for pedestrians by tightening curb radii thereby reducing the speeds of turning vehicles. Intersection treatments can be retrofit into existing intersections without modifying the existing drainage or they can be designed to provide additional sidewalk width for increased pedestrian use or street furniture. The effects are increased pedestrian comfort and safety at the intersection.

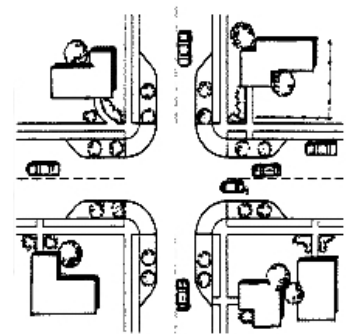

#### Measured Impacts

Speed Impacts	Reduction in 85th Percentile Speeds between Slow Points	-7%
Volume Impacts	Reduction in Vehicles per Day	-10%

Source: Traffic Calming: State of the Practice, 2000.

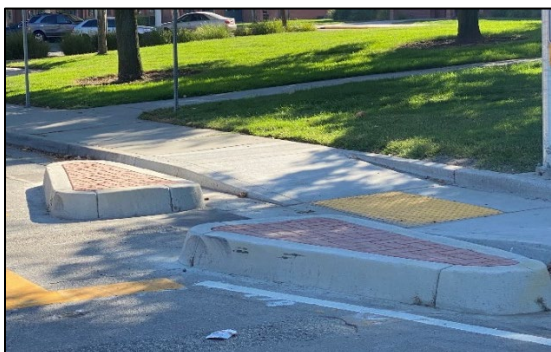

Source: City of Stockton (2020)

### Advantages

- Improves pedestrian circulation and standing space on sidewalk area
- Through and left-turn movements are easily negotiable by large vehicles
- Creates protected on-street parking bays
- Reduces speeds (especially right-turning vehicles) and traffic volumes
- Provides opportunity for landscaping and street furniture

### Disadvantages

- Effectiveness is limited by the absence of vertical or horizontal deflection
- May slow right-turning emergency vehicles
- Potential loss of on-street parking
- May require bicyclists to briefly merge with vehicular traffic

<sup>3</sup>This requires further studies and approval prior to implementation

## TWO-LANE CHOKER

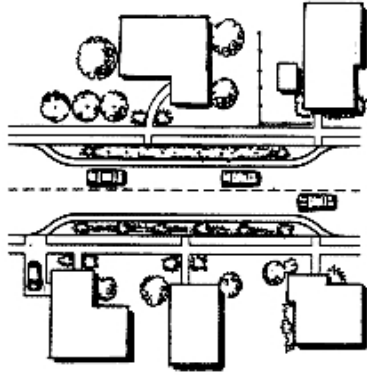

Chokers are curb extensions at mid-block that narrow a street by widening the sidewalk or planting strip. If marked as crosswalks, they are also called safe crosses. Chokers leave the street cross section with two lanes that are narrower than the normal cross section.

### Measured Impacts

Speed Impacts	Reduction in 85th Percentile Speeds between Slow Points	-7%
Volume Impacts	Reduction in Vehicles per Day	-10%

Source: US Traffic Calming Manual (2009)



Source: Fehr & Peers (2020)

### Advantages

- Easily negotiable by large vehicles (such as fire trucks)
- If designed well, can have positive aesthetic value
- Reduces both speeds and volumes
- Opportunity for landscaping

### Disadvantages

- Effect on vehicle speeds is limited by the absence of any horizontal deflection
- May require bicyclists to briefly merge with vehicular traffic
- Potential loss of on-street parking
- Maintenance of landscaping (City vs. residents)

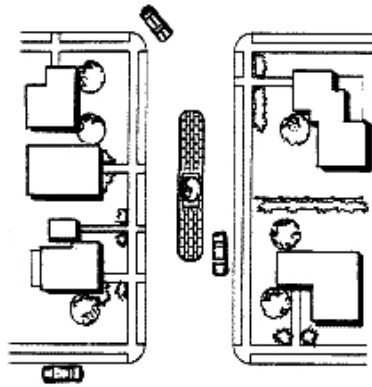

## CENTER ISLAND NARROWING/PEDESTRIAN REFUGE ISLAND

Center island narrowing are raised islands located along the centerline of a street that narrow the travel lanes at that location. They are often landscaped to provide visual amenity. Placed at the entrance to a neighborhood and often combined with textured pavement, they are sometimes called "gateways." Fitted with a gap to allow pedestrians to walk through at a crosswalk, they are often called "pedestrian refuges."

### Measured Impacts

Speed Impacts	Reduction in 85th Percentile Speeds between Slow Points	-7%
Volume Impacts	Reduction in Vehicles per Day	-10%

Source: Traffic Calming: State of the Practice, 2000.

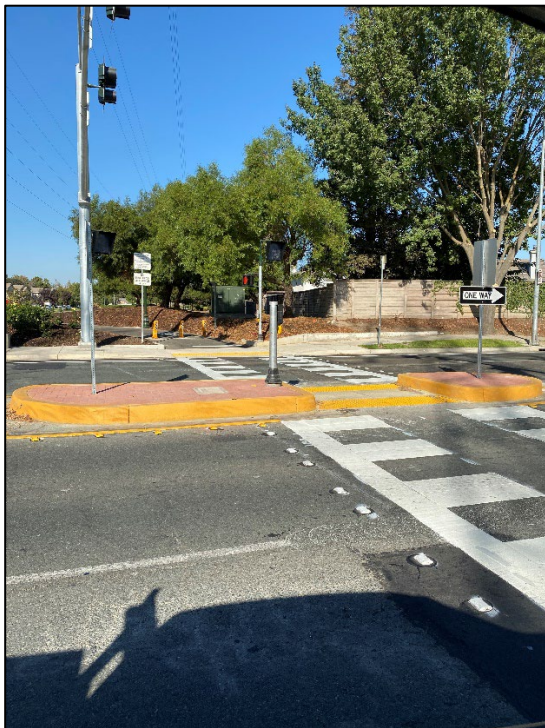

Source: City of Stockton (2020)

### Advantages

- Increases pedestrian safety
- If designed well, can have positive aesthetic value
- Reduces traffic volumes
- Opportunity for landscaping

### Disadvantages

- Effect on vehicle speeds is limited by the absence of any vertical or horizontal deflection
- Potential loss of on-street parking
- Maintenance of landscaping (City vs. residents)



## Horizontal Deflection Devices<sup>4</sup>

### Description

Horizontal deflection devices use raised islands and curb extensions to eliminate straight-line paths along roadways and through intersections. The horizontal deflection devices in the toolbox include:

- **Traffic Circles**
- **Roundabouts**
- **Chicanes**

---

<sup>4</sup> This requires further studies and approval prior to implementation

## TRAFFIC CIRCLE

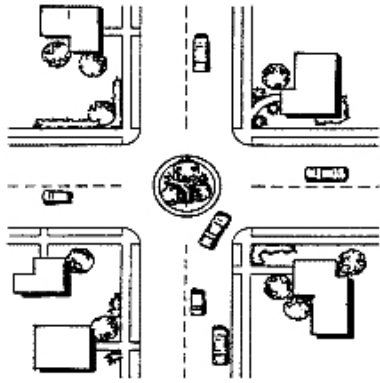

Traffic circles are raised islands, placed in intersections, around which traffic circulates. They are usually circular in shape and landscaped in their center islands, though not always. Traffic controls at the approaches vary by

location. Circles prevent drivers from speeding through intersections by impeding the straight-through movement and forcing drivers to slow down to yield. Drivers must first turn to the right, then to the left as they pass the circle, and then back to the right again after clearing the circle.

### Advantages

- If designed well, can have positive aesthetic value
- Very effective in moderating speeds and improving safety
- Opportunity for landscaping

### Disadvantages

- Difficult for large vehicles (such as fire trucks) to circumnavigate
- Must be designed so that the circulating lane does not encroach on crosswalks
- Potential loss of on-street parking
- Maintenance of landscaping (City vs. residents)

### Measured Impacts

Speed Impacts	Reduction in 85th Percentile Speeds between Slow Points	-11%
Volume Impacts	Reduction in Vehicles per Day	-5%
Safety Impacts	Reduction in Average Annual Number of Collisions	-71%

Source: Traffic Calming: State of the Practice, 2000.



Source: Fehr & Peers (2020)

## ROUNDABOUT (per FHWA-SA-15-074/City Standard)

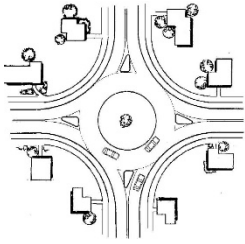

Like traffic circles, roundabouts require traffic to circulate counterclockwise around a center island. But unlike circles, roundabouts are used on higher volume streets to allocate rights-of-way among competing movements. They are found primarily on arterial and collector streets, often substituting for traffic signals or all-way STOP signs. They are larger than neighborhood traffic circles and typically have raised splitter islands to channel approaching traffic to the right.

Measured Impacts		
Speed Impacts	Reduction in 85th Percentile Speeds between Slow Points	I/D
Volume Impacts	Reduction in Vehicles per Day	I/D
Safety Impacts	Reduction in Average Annual Number of Collisions	-1.5% to 33%

Notes: I/D = Insufficient Data

Source: Traffic Calming: State of the Practice, 2000.



Source: Fehr & Peers (2020)

### Advantages

- Moderates traffic speed on an arterial
- Enhanced safety compared to a traffic signal
- Minimizes queuing at approaches to the intersection
- Less expensive to operate than traffic signals
- Provides opportunity for landscaping and street furniture

### Disadvantages

- May require major reconstruction of an existing intersection
- Loss of on-street parking
- Increases pedestrian distance from one crosswalk to the next
- Difficult for visually impaired pedestrian to navigate
- Maintenance of landscaping (City vs. residents)

## CHICANE

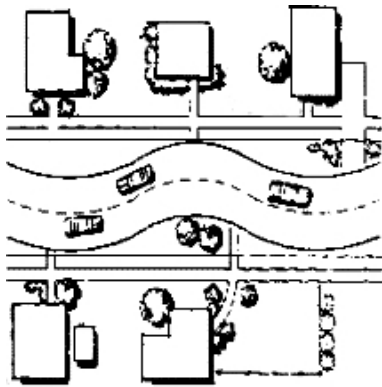

Chicanes are curb extensions that alternate from one side of the street to the other, forming S-shaped curves. Chicanes can also be created by alternating on-street parking, either diagonal or parallel, between one side of the road and the other. Each parking bay can be created either by restriping the roadway or by installing raised landscaped islands at each end, creating a protected parking area.

### Measured Impacts

Speed Impacts	Reduction in 85th Percentile Speeds between Slow Points	I/D
Volume Impacts	Reduction in Vehicles per Day	I/D
Safety Impacts	Reduction in Average Annual Number of Collisions	I/D

Notes: I/D = Insufficient Data

Source: Traffic Calming: State of the Practice, 2000.



Source: Fehr & Peers (2020)

### Advantages

- Discourages high speeds by forcing horizontal deflection
- Easily negotiable by large vehicles (such as fire trucks) except under heavy traffic conditions
- Provides opportunity for landscaping and street furniture

### Disadvantages

- Must be designed carefully to discourage drivers from deviating out of the appropriate lane
- Curb realignment and landscaping can be costly, especially if there are drainage issues
- Potential loss of on-street parking
- Maintenance of landscaping (City vs. residents)

## Vertical Deflection Devices<sup>5</sup>

### Description

Vertical deflection devices use variations in pavement height and alternative paving materials to cause drivers discomfort at high travel speeds. The vertical deflection devices in the toolbox include:

- **Speed Humps**
- **Speed Cushions**
- **Split Devices**
- **Speed Tables**
- **Raised Crosswalks**
- **Raised Intersections**

---

<sup>5</sup> This requires further studies and approval prior to implementation

## SPEED HUMP

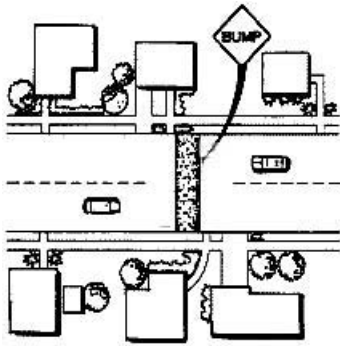

Speed Humps are rounded raised areas placed across the road. They are generally 12 feet long (in the direction of travel), 3 ¼ to 3 ¾ inches high, and parabolic in shape, and have a design speed of 15 to 20 mph. They are usually constructed with AC and have a taper on each side to allow unimpeded drainage between the hump and curb. When placed on a street with rolled curbs or no curbs, bollards are placed at the ends of the speed hump to discourage vehicles from veering outside of the travel lane to avoid the device. Speed humps are not installed on emergency response or SJRTD routes.

### Measured Impacts

Speed Impacts	Reduction in 85th Percentile Speeds between Slow Points	-18%
Safety Impacts	Reduction in Average Annual Number of Collisions	-13%

Source: Traffic Calming: State of the Practice, 2000.



Source: City of Stockton (2020)

### Advantages

- Relatively inexpensive
- Relatively easy for bicyclists to cross if taper is designed appropriately
- No loss of on-street parking
- Very effective in slowing travel speeds

### Disadvantages

- Causes a “rough ride” for all drivers, and can cause severe pain for people with certain skeletal disabilities
- Emergency vehicles forced to travel at slower speeds
- Increased noise to adjacent residences
- Aesthetics

## SPEED CUSHION

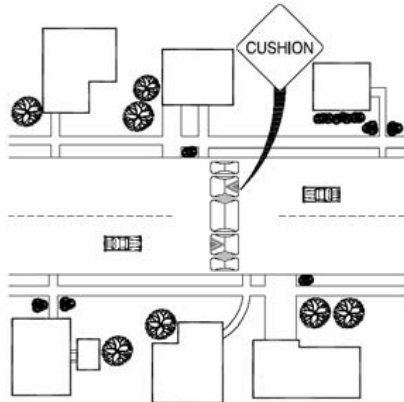

The City has replaced the prefabricated, rubber speed cushion with a similar design constructed out of concrete or asphalt. These can be built with tapers.

The speed cushion is a variation of the speed hump with two wheel cut-outs. Each cushion has a width of 6.5 feet to accommodate the wheelbase of fire trucks and buses so they can pass through without slowing. For standard size vehicles to pass, at least one set of wheels must travel over the cushion. Speed cushions are installed on emergency response and SJRTD routes.

### Measured Impacts

Speed Impacts	Reduction in 85th Percentile Speeds between Slow Points	Comparable to speed humps, but I/D
Safety Impacts	Reduction in Average Annual Number of Collisions	

Source: Traffic Calming: State of the Practice, 2000.



Source: City of Stockton (2020)

### Advantages

- Relatively inexpensive
- No loss of on-street parking
- Effective in slowing travel speeds

### Disadvantages

- Large (non-standard) vehicles and motorcycles can avoid the lump by passing through the cut-outs
- Increased noise to adjacent residences
- Aesthetics

## SPEED TABLE

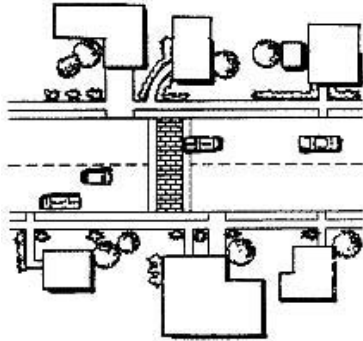

Speed tables are flat-topped speed humps often constructed with a brick or other textured materials on the flat section. Speed tables are typically long enough for the entire wheelbase of a passenger car to rest on top. Their long flat fields, plus ramps that are sometimes more gently sloped than speed humps, give speed tables higher design speeds than humps. The brick or other textured materials improve the appearance of speed tables, draw attention to them, and may enhance safety and speed reduction.

Measured Impacts		
Speed Impacts	Reduction in 85th Percentile Speeds between Slow Points	-18%
Volume Impacts	Reduction in Vehicles per Day	-12%
Safety Impacts	Reduction in Average Annual Number of Collisions	-45%

Source: Traffic Calming: State of the Practice, 2000.



Source: City of Stockton (2020)

### Advantages

- Smoother on large vehicles such as fire trucks than speed humps
- Effective in slowing travel speeds, though not to the extent of speed humps
- Can provide a safer pedestrian crossing
- Aesthetically pleasing

### Disadvantages

- Textured materials can be expensive
- Causes a rough ride



## RAISED CROSSWALK

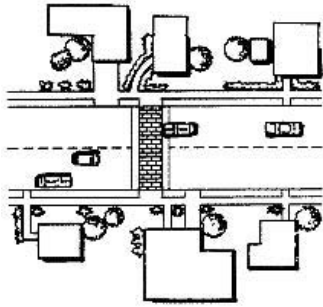

Raised crosswalks are speed tables outfitted with crosswalk markings and signage to channelize pedestrian crossings providing pedestrians with a level street crossing. Also, by raising the level of the crossing, pedestrians are more visible to approaching motorists.

### Measured Impacts

Speed Impacts	Reduction in 85th Percentile Speeds between Slow Points	-18%
Volume Impacts	Reduction in Vehicles per Day	-12%
Safety Impacts	Reduction in Average Annual Number of Collisions	-45%

Source: Traffic Calming: State of the Practice, 2000.

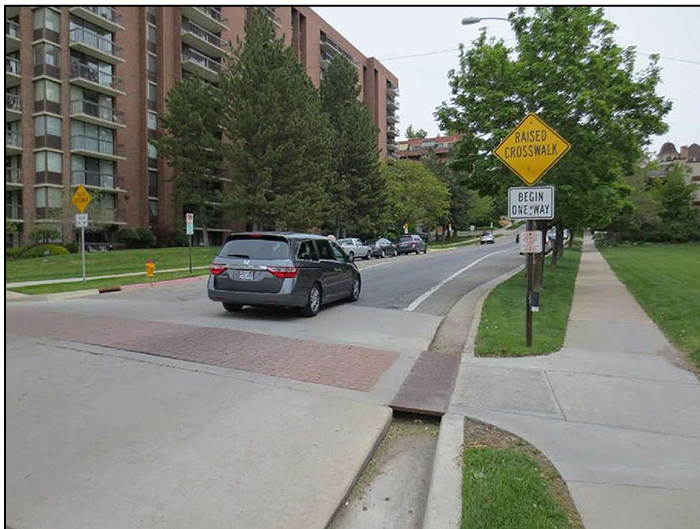

Source: FHWA (2015)

### Advantages

- Improves safety for both vehicle and pedestrians
- If designed well, can have positive aesthetic value
- Effective in reducing speeds, though not to the extent of speed humps

### Disadvantages

- Textured materials can be expensive
- Increased noise to adjacent residences
- Impact to drainage needs to be considered

## RAISED INTERSECTION

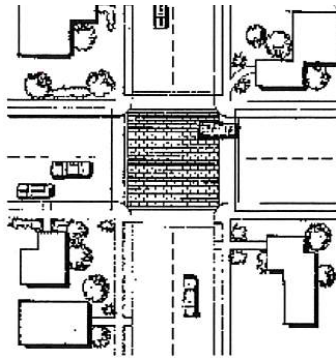

Raised intersections are flat raised areas covering entire intersections, with ramps on all approaches and often with brick or other textured materials on the flat section. They usually rise to sidewalk level, or slightly below to provide a “lip” for the visually impaired. By modifying the level of the intersection, the crosswalks are more readily perceived by motorists to be pedestrian territory. They are particularly useful in dense urban areas, where the loss of on-street parking associated with other traffic calming measures is considered unacceptable.

### Measured Impacts

Speed Impacts	Reduction in 85th Percentile Speeds between Slow Points	-1%
---------------	---	-----

Source: Traffic Calming: State of the Practice, 2000.



Source: NACTO (credit: Eric Tuvel)

### Advantages

- Improves safety for both pedestrians and automobiles
- Can have positive aesthetic value
- Can calm two streets at once

### Disadvantages

- Less effective in reducing vehicle speeds than speed humps or speed tables
- Expensive, varying by materials used

## Diversion Devices<sup>6</sup>

### Description

Diversion devices use raised islands and curb extensions to preclude particular vehicle movements, such as left-turn or through movements, usually at an intersection. The diversion devices in the toolbox include:

- **Full Closures**
- **Half Closures**
- **Median Barriers**
- **Forced Turn Islands**

---

<sup>6</sup> This requires further studies and approval prior to implementation

## FULL CLOSURE

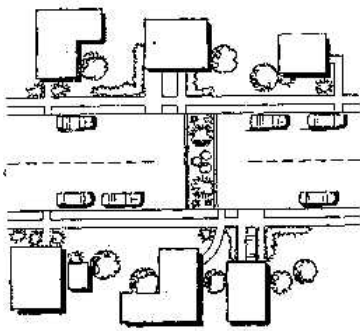

Full street closures are barriers placed across a street to close the street completely to through traffic, usually leaving only sidewalks or bicycle paths open. The barriers may consist of landscaped islands, walls, gates, side-by-side bollards, or any other obstructions that leave an opening smaller than the width of a passenger car.

### Measured Impacts

Volume Impacts	Reduction in Vehicles per Day	-44%
----------------	-------------------------------	------

Source: Traffic Calming: State of the Practice, 2000.



Source: City of Stockton (2020)

### Advantages

- Able to maintain pedestrian and bicycle access
- Very effective in reducing traffic volumes
- Opportunity for landscaping

### Disadvantages

- Requires legal procedures for public street closures
- Causes circuitous routes for local residents and emergency services
- May be expensive
- May limit access to businesses
- Maintenance of landscaping (City vs. residents)

## HALF CLOSURE

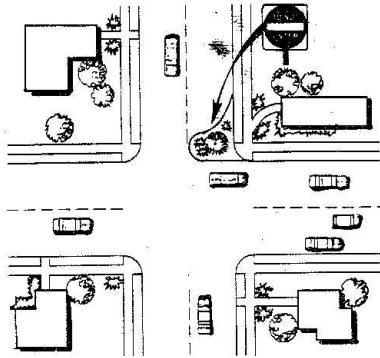

Half street closures are barriers that block travel in one direction for a short distance on otherwise two-way streets. Half closures are the most common volume control measure after full street closures. Half closures are often used in sets to make travel through neighborhoods with gridded streets circuitous rather than direct. That is, half closures are not lined up along a border, which would preclude through movement, but instead are staggered, which leaves through movement possible but less attractive than alternative routes.

### Measured Impacts

Speed Impacts	Reduction in 85th Percentile Speeds between Slow Points	-19%
Volume Impacts	Reduction in Vehicles per Day	-42%

Source: Traffic Calming: State of the Practice, 2000.



Source: City of Stockton Traffic Calming Guidelines (2008)

### Advantages

- Able to maintain two-way bicycle access
- Effective in reducing traffic volumes

### Disadvantages

- Causes circuitous routes for local residents and emergency services
- May limit access to businesses
- Drivers can circumvent the barrier

## MEDIAN BARRIER

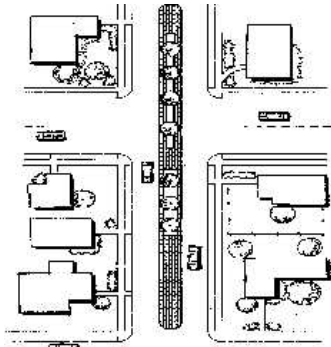

Median barriers are raised islands that are located along the centerline of a street and continue through an intersection so as to block through movement at a cross street.

### Measured Impacts

Volume Impacts	Reduction in Vehicles per Day	-31%
----------------	-------------------------------	------

Source: Traffic Calming: State of the Practice, 2000.



Source: City of Stockton Traffic Calming Guidelines (2008)

### Advantages

- Can improve safety at an intersection of a local street and a major street by prohibiting dangerous turning movements
- Can reduce traffic volumes on a cut-through route that crosses a major street

### Disadvantages

- Requires available street width on the major street
- Limits turns to and from the side street for local residents and emergency services

## FORCED-TURN ISLAND

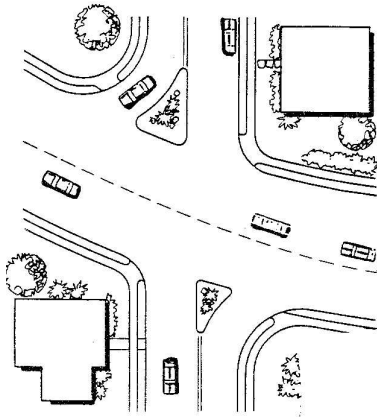

Forced turn islands are raised islands that block certain movements on approaches to an intersection.

### Measured Impacts

Volume Impacts	Reduction in Vehicles per Day	-31%
----------------	-------------------------------	------

Source: Traffic Calming: State of the Practice, 2000.



Source: City of Stockton (2020)

### Advantages

- Can improve safety at an intersection of a local street and a major street by prohibiting dangerous turning movements
- Reduces traffic volumes

### Disadvantages

- If designed improperly, drivers can maneuver around the island to make an illegal movement
- May simply divert a traffic problem to a different street

## Effectiveness Comparison

Table 4 summarizes the effectiveness data that has been compiled for each of the traffic calming measures in the toolbox. Note that these data are averages. Actual effectiveness can vary based on site-specific circumstances, such as proximity to major roads and the availability of alternate routes.

**Table 4 – Quantitative Impacts of Traffic Calming Measures**

Types of Measures	Effectiveness										
	85th Percentile Speeds				Vehicles per Day		Average Annual Collisions				
	Before	After	Change	Percent Change	Change	Percent Change	Before	After	Change	Percent Change	
<b>Non-Physical Measures</b>											
I/D											
<b>Narrowing Measures</b>											
	Bulbouts	34.9	32.3	-2.6	-7%	-293	-10%	I/D			
	Two-Lane Chokers										
	Center Island										
	Narrowing/ Pedestrian Refuges										
<b>Horizontal Measures</b>											
	Traffic Circles	34.2	30.3	-3.9	-11%	-293	-5%	2.19	0.64	-1.55	-71%
	Roundabouts (Single-Lane)	Insignificant Speed Effects				Insignificant Volume Effects		Not Recorded			-15% to -33%
	Lateral Shifts	I/D				I/D		I/D			
	Chicanes	I/D				I/D		I/D			
<b>Vertical Measures</b>											
	Speed Hump	35.0	27.4	-7.6	-22%	-335	-18%	2.62	2.29	-0.33	-13%
	Speed Cushion	Comparable to Speed Hump but I/D									
	Speed Table	36.7	30.1	-6.6	-18%	-415	-12%	6.71	3.66	-3.05	-45%
	Raised Crosswalk										
	Raised Intersection	34.6	34.3	-0.3	-1%	I/D		I/D			
	Textured Pavement	I/D				I/D		I/D			
<b>Diversion Measures</b>											
	Full Closures	I/D	I/D	I/D	I/D	-671	-44%	I/D			
	Half Closures	32.3	26.3	-6.0	-19%	-1,611	-42%	I/D			
	Diagonal Diverters	29.3	27.9	-1.4	-4%	-501	-35%	I/D			
	Median Barriers	I/D	I/D	I/D	I/D	-1,167	-31%	I/D			
	Forced Turn Islands										
Notes: I/D = Insufficient Data											
Source: <i>Traffic Calming: State of the Practice</i> (Ewing, 1999)											



# Design Guidelines

This chapter identifies some physical design considerations and constraints associated with the traffic calming measures in the toolbox in the previous chapter. Engineering designs for the standard traffic calming measures in Stockton's NTMP toolbox are contained in Appendix A.

## Emergency Response Routes

Because every situation is different, variations on the standard traffic calming devices may be appropriate in some cases. The NTMP promotes the consideration of these existing experimental measures and the exploration of new measures through continuous dialogue between Public Works, emergency services staff, and citizens of the community. The development of an official "Emergency Response Route" may aid City staff and TCC members in selecting devices that would least likely impact emergency response times.

## Horizontal Deflection Measures

### Traffic Circle Placement

Traffic circles are very effective in moderating speeds in existing neighborhoods. They are distinct from roundabouts in that they typically are placed within the existing curb area, retain the existing traffic controls, and are exclusively intended to reduce speeds (roundabouts also regulate traffic flow).

Traffic Circles can also be incorporated into new developments as seen fit by Development Services Review. The above installation criterion also applies.

### Traffic Circle Center Island Profile

Traffic circles should be designed with both a square inner curb and a mountable apron. The apron is a shallow-sloped curb extending out from the bottom of a square curb; the apron has a low lip at its pavement-side edge. This apron effectively reduces the diameter of the center island for large vehicles, facilitating easier turns. The low lip at the apron's edge discourages vehicles from using it unless it is necessary.

### Traffic Circle Turn Operations

All vehicles should circulate around the center island on left-turns.

### Traffic Circles at T-Intersections

Traffic circles should have deflection on all approaches if implemented at a T-intersection. This can be implemented using one of two methods. First, a raised island can be placed at the right side of the un-deflected approach to the traffic circle to artificially introduce deflection, as shown in Figure 2 (a). Alternatively, the street curbs can be modified to allow the center island to be located at the center of the intersection, as shown in figure (b). This method may require the acquisition of additional right-of-way.

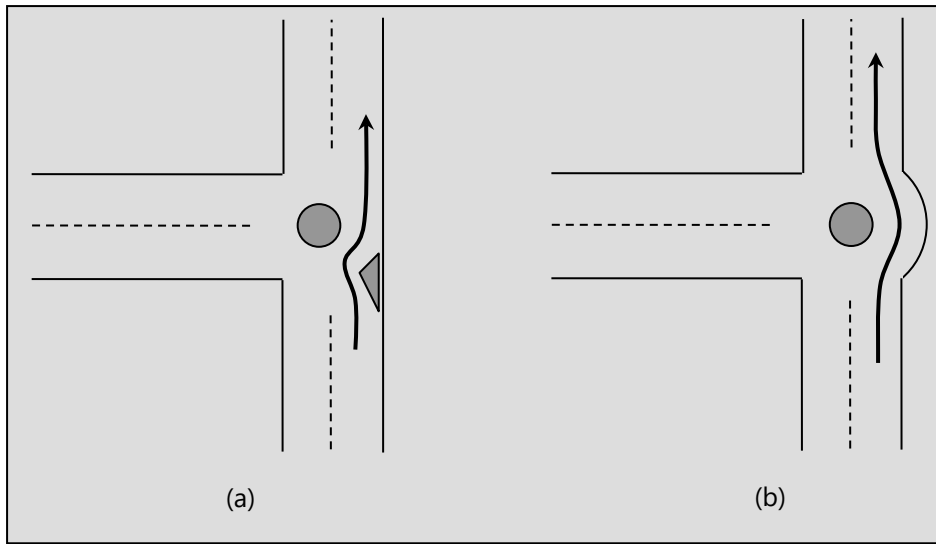

## Signing & Marking

Concurrent with the installation of traffic calming devices, device-specific symbol-based signs will be installed (Appendix A). At the discretion of Public Works staff, advanced warning signs may also be installed. Traffic circle center islands will include signage symbolically indicating the permitted travel paths around the center island (Appendix A).

Special signing for bicyclists should be provided on designated bikeways. For example, the approaches to narrowing devices that do not include a bypass lane for bicyclists will include signage warning motorists to watch for merging bicyclists.

## Combined Measures

Some measures from the toolbox can be combined to increase the combined effect on traffic volumes and speeds. For example, a center island narrowing may be combined with bulbouts, with the effect of a much shorter walking distance. Motorists must also react to the narrower lane and object on either side. In assessing the suitability of a proposed combined measure, the guidelines in Table 1 for both of the component devices should be applied.

## Roundabouts

Roundabouts are a unique traffic control device that may be useful in a variety of situations. They are often used in lieu of all-way stop control or traffic signals as a means of increasing the capacity of the intersection and improving its operations. Roundabout treatments should be considered when a local street and collector or two collector streets meet with an ADT greater than 2,000. Roundabouts can also be designed into new developments based on the same criteria.

Roundabouts require a considerably more rigorous design process than the other traffic calming devices in the toolbox. Because of their complex design features, no generic design is included in this document. However, roundabouts should generally have the following characteristics:

- A circular travel lane operating counter-clockwise for collecting and distributing traffic
- A raised center island
- Channelized approaches
- Yield control at all approaches
- Tapered approaches to encourage entering vehicles to travel in the correct direction through the circular travel lane

In general, roundabouts in the United States tend to be used on collector streets and on low-volume minor arterial streets. The use of roundabouts is primarily constrained by traffic volumes and by geometrics. The design of every roundabout should be customized using detailed traffic and geometric information and procedures beyond what is presented here. The cursory check found in Appendix B can be helpful in determining whether a roundabout is a reasonable option to consider. Also, the following examples illustrate cases where a roundabout may be appropriate:

- **History of Collisions** – For example, roundabouts are placed at intersections with a history of accidents, especially head-on collisions and right-angle collisions. A roundabout can help improve safety by substantially reducing the number of conflict points and by simplifying interactions between vehicles.
- **Minimizing Queues** – Another case is a collector/arterial intersection located near an arterial/arterial intersection. A roundabout may be useful here because it can allocate right-of-way between both the arterial and the collector, while minimizing the queues on the approach stemming from the arterial/arterial intersection.
- **Handling Irregular Approach Geometry** – An intersection with greater than four approaches or with approaches that meet the intersection at irregular angles may be a candidate for a roundabout.
- **Inexpensive Traffic Control** – In some cases, traffic volumes at an intersection may be too high to allow acceptable operations with all-way stop control, a traffic signal is considered inappropriate due to sight distance or other constraints. If ample right-of-way is already available, a roundabout may be considered.
- **High Proportion of U-Turns** – If an intersection is situated where U-turns are frequent, a roundabout can facilitate those U-turns without adversely affecting the operations of the intersection as a whole.
- **Pedestrian Accommodation** – Roundabouts represent a trade-off for pedestrians. They can be inconvenient for pedestrians because the crosswalks are set back farther from the intersection. Additionally, roundabouts pose as a greater challenge to the visually impaired than typical intersections do. However, they are also superior to signalized intersections because crossing distances are shorter and are broken by a pedestrian refuge, and pedestrians do not need to wait for the pedestrian signal through a long traffic signal cycle.

## Vertical Deflection Measures – Humps and Cushions Installation

Speed humps and speed cushions may be installed on City streets in neighborhoods selected to participate in the Neighborhood Traffic Management Program (NTMP) if the following conditions are met. In addition, Public Works staff will coordinate with the Fire Department, SJRTD, and local school districts during the review process of proposed traffic calming plans that include speed humps or speed cushions.

1. The street must be two lanes and primarily function as a local residential or minor collector street.
2. The speed limit must be 30 mph or less.
3. The street frontage of subject segment must consist of at least 75% residential development except when fronted by a school or park.
4. The street segment must be at least 500 feet in length between traffic controls, four-way intersections, and/or curves with less than a 250-foot radius.

### Selection of Precise Installation Locations

In selecting precise locations for the speed hump/cushions, the following guidelines shall be followed. For simplicity, the term speed hump refers to both the speed hump and speed cushion.

1. Speed humps shall not be located over manholes, water valves, or street monuments, or whenever possible, within fifteen feet of fire hydrants, as they prevent/impede access to these facilities.
2. Speed humps should be located five to ten feet away from driveways, whenever possible, to minimize their effect on driveway access.
3. Speed humps should be located on or near property lines, whenever possible, to minimize the impact on individual properties.
4. Speed humps should be located near streetlights, whenever possible, in order to enhance their visibility at night.
5. Speed humps should be located a minimum distance of 100 feet from corners with uncontrolled crossings, whenever possible, and shall never be located within a corner radius.
6. Speed humps shall be placed no closer than 100 feet from traffic control devices or four-way intersections.
7. Where speed humps are constructed on streets having curves with greater than a 250-foot radius, no speed hump shall be located on the horizontal curve(s).
8. Speed humps shall be spaced at a minimum interval of 250 feet and a maximum interval of 500 feet.
9. To deter motorists from driving around speed humps where no vertical curb exists, a two-inch pipe should be set in the sidewalk, centered on the speed hump. The pipes shall be placed at a maximum of six inches from the back of curb.

### Signs and Markings

1. Advance warning signs and supplemental speed advisory signs shall be installed per the current MUTCD.
2. Pavement markings for speed humps shall be installed per the current MUTCD.

3. Pavement marking for speed cushions should include diamond striping (or centerline if appropriate) on the center cushion.

# References

To find out more about Traffic Calming and Neighborhood Traffic Management, please see the web sites and documents listed below:

## Local Traffic Calming Programs

- City of Sacramento. (2002b). Neighborhood Traffic Management Program (Web Site: <http://pw.sacto.org/traffic/ntmp.html>). Sacramento, CA: City of Sacramento, Department of Public Works.
- City of Austin (2002). Neighborhood Traffic Management Program (Web Site: <http://www.ci.austin.tx.us/roadworks/tc.htm>). Austin, TX: City of Austin Department of Public Works and Transportation.
- City of Portland (2002). Portland Traffic Calming Program (Web Site: <http://www.trans.ci.portland.or.us/trafficalming/default.htm>). Portland, OR: City of Portland Neighborhood Traffic Management.
- City of Seattle (2002). Neighborhood Traffic Control Program (Web Site: <http://www.seattle.gov/transportation/ntcphome.htm>). Seattle, WA: Seattle Transportation.
- Ewing, R. (2000). *Delaware Traffic Calming Design Manual*. Wilmington, DE: Delaware Department of Transportation.

## General Information on Traffic Calming

- Burden, Dan. (1999). *Street Design Guidelines for Healthy Neighborhoods*. Sacramento, CA: Local Government Commission.
- County Surveyors Society. (1994). *Traffic Calming in Practice*. London: Landor Publishing.
- Ewing, R. (1999). *Traffic Calming: State of the Practice*. Washington, DC: Institute of Transportation Engineers/Federal Highway Administration.
- Fehr & Peers. (1999). Traffic Calming .Org (Web Site: <http://www.trafficalming.org>). Lafayette, CA: Fehr & Peers Associates, Inc.
- ITE (2002). Traffic Calming...for Communities (Web Site: <http://www.ite.org/traffic/index.html>). Washington, DC: Institute of Transportation Engineers.
- Hass-Klau, C. et al. (1992). *Civilised Streets: A Guide to Traffic Calming*. Brighton, U.K.: Environment & Transport Planning.
- Hehrstedt, L. et al. (1993). *An Improved Traffic Environment: A Catalogue of Ideas*. Copenhagen, Denmark: Danish Road Directorate.
- Litman, T. (2001). Online TDM Encyclopedia (Web Site: <http://www.vtpi.org/tdm/>). Victoria, BC: Victoria Transport Policy Institute.
- Smith, D. T. Jr. and D. Appleyard. (1980). *State of the Art: Residential Traffic Management*. Washington, DC: Federal Highway Administration.

- TAC. (1998). *Canadian Guide to Neighbourhood Traffic Calming*. Ottawa, Canada: Transportation Association of Canada.
- Tolley, R. (1990). *Traffic in Residential Areas*. Brefi, U.K.: Brefi Press.

### **Roundabouts**

- Robinson, B. W. et al (2000). *Roundabouts: An Informational Guide*. Washington, DC: Federal Highway Administration.
- Wallwork, M. (2002). Modern Roundabouts (Web Site: <http://www.roundabouts.net>). Orange Park, FL: Alternate Street Design, P.A.

# Appendix A:

## Standard Traffic Calming Device Designs

Triple 4 Crosswalk .....	A-2
Traffic Circle .....	A-3
Chicane .....	A-4
Bulbout (Midblock treatment).....	A-5
Bulbout (Intersection treatment) .....	A-6
Center Island Narrowing .....	A-7
Choker.....	A-8
Speed Hump.....	A-9
Speed Cushion.....	A-10
Speed Table .....	A-12
Raised Crosswalk .....	A-13
Raised Intersection.....	A-14
Half Closure .....	A-15
Median Barrier .....	A-17
Forced Turn Island .....	A-18
Warning Signs.....	A-19



Figure A-2: Triple 4 Crosswalk

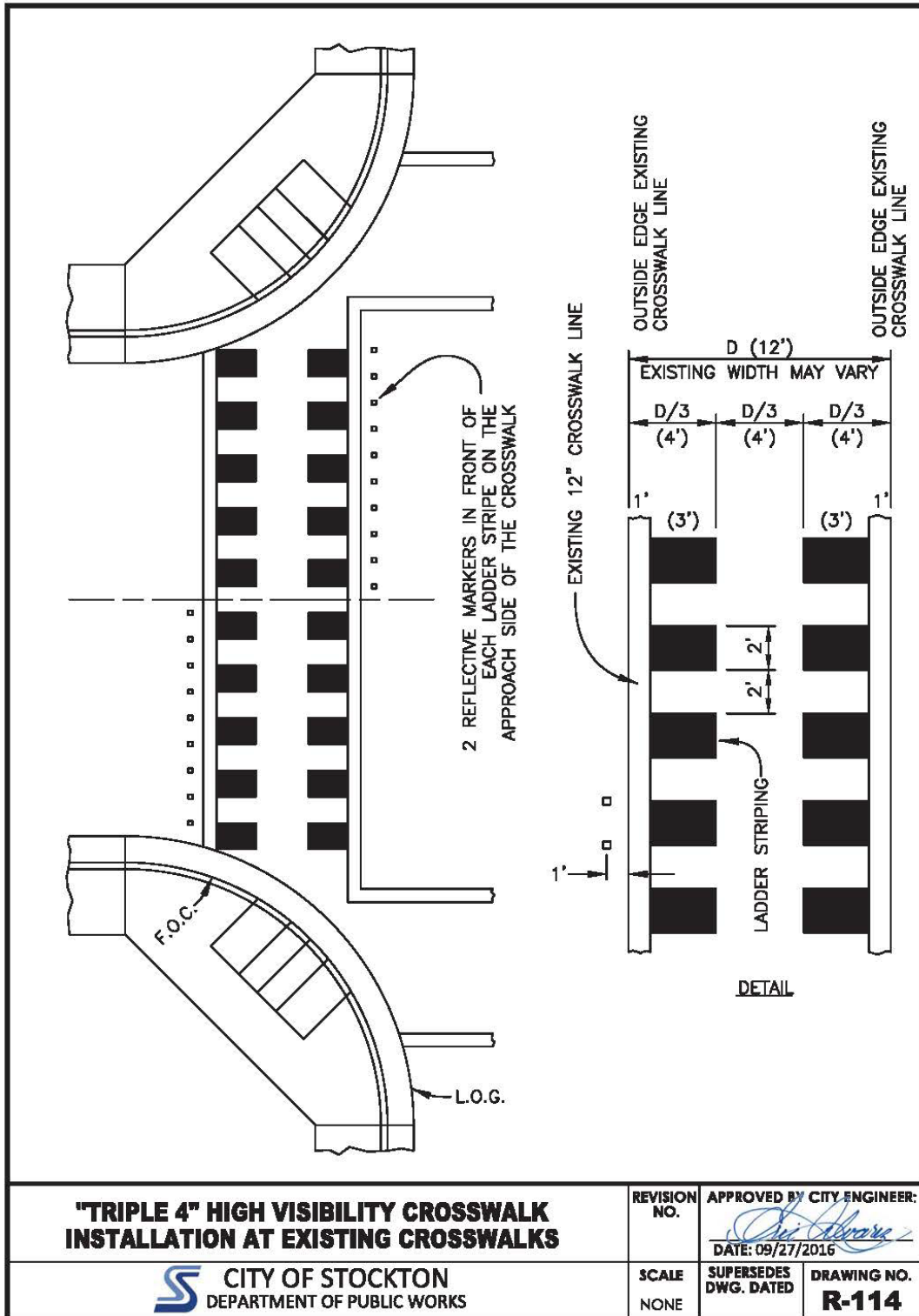

**"TRIPLE 4" HIGH VISIBILITY CROSSWALK  
INSTALLATION AT EXISTING CROSSWALKS**

**CITY OF STOCKTON**  
DEPARTMENT OF PUBLIC WORKS

REVISION  
NO.

APPROVED BY CITY ENGINEER:

*[Signature]*  
DATE: 09/27/2016

SCALE  
NONE

SUPERSEDES  
DWG. DATED

DRAWING NO.  
**R-114**

Figure A-3: Traffic Circle

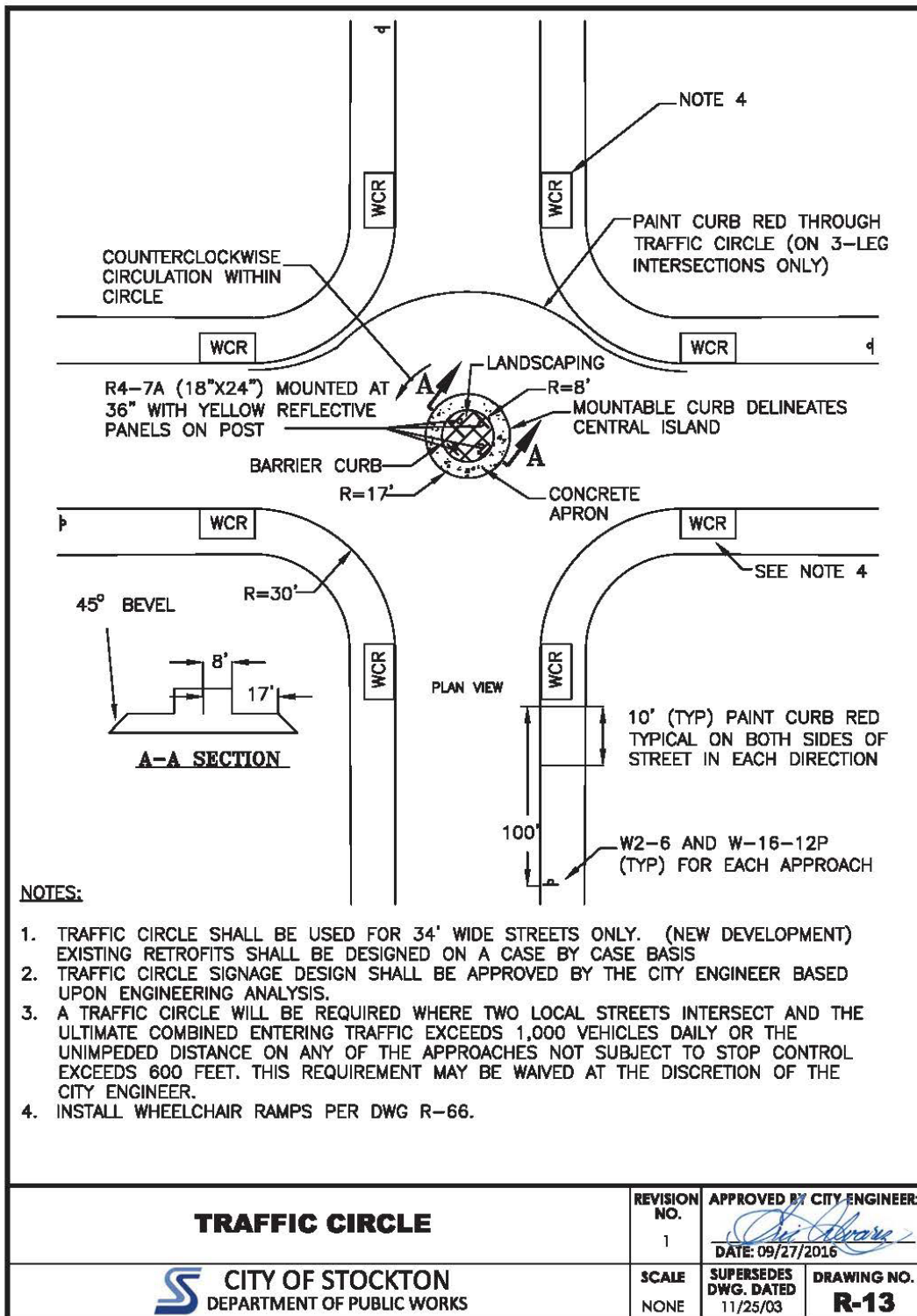

Figure A-4: Chicane

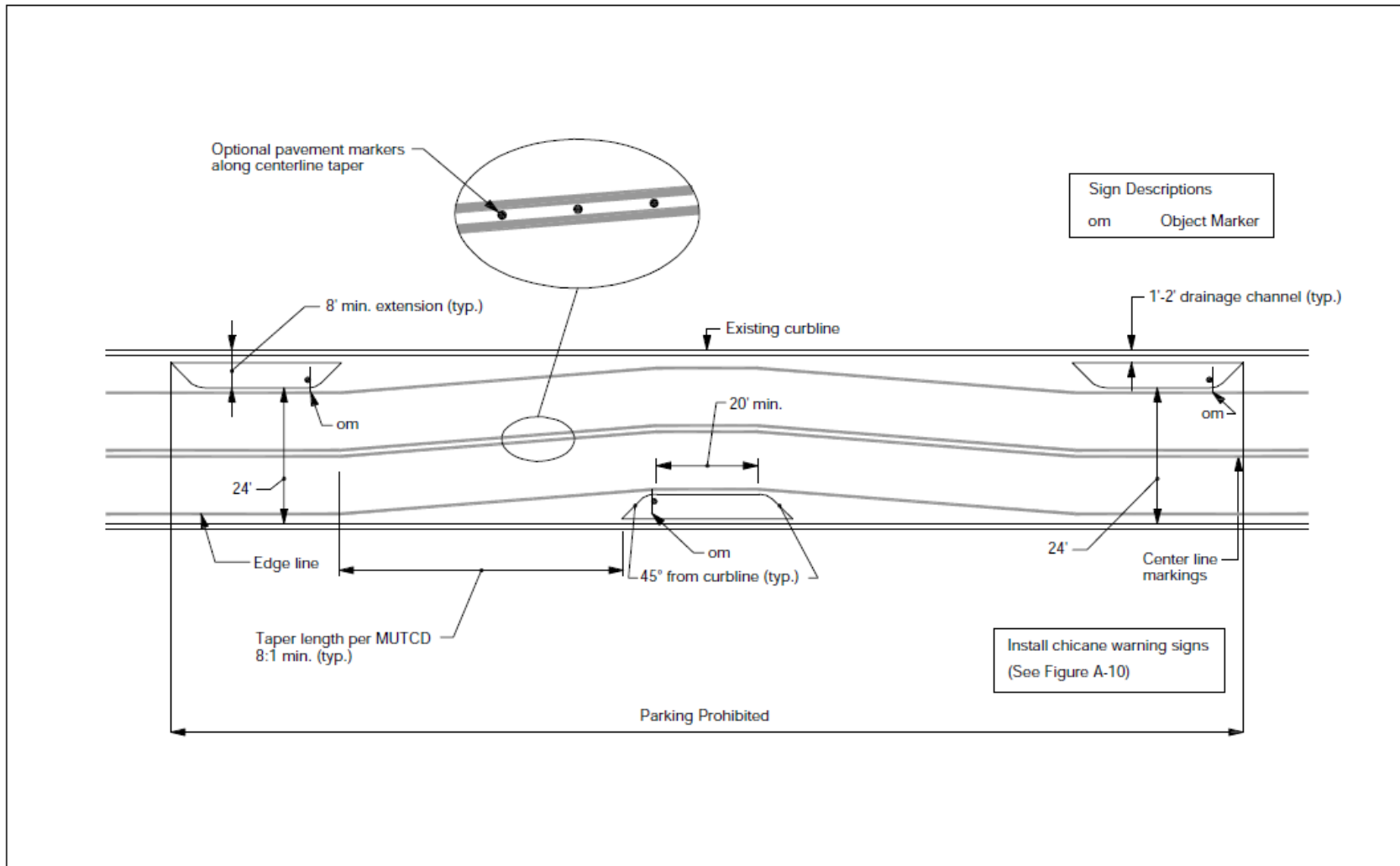

Figure A-5: Bulbout (Midblock Treatment)

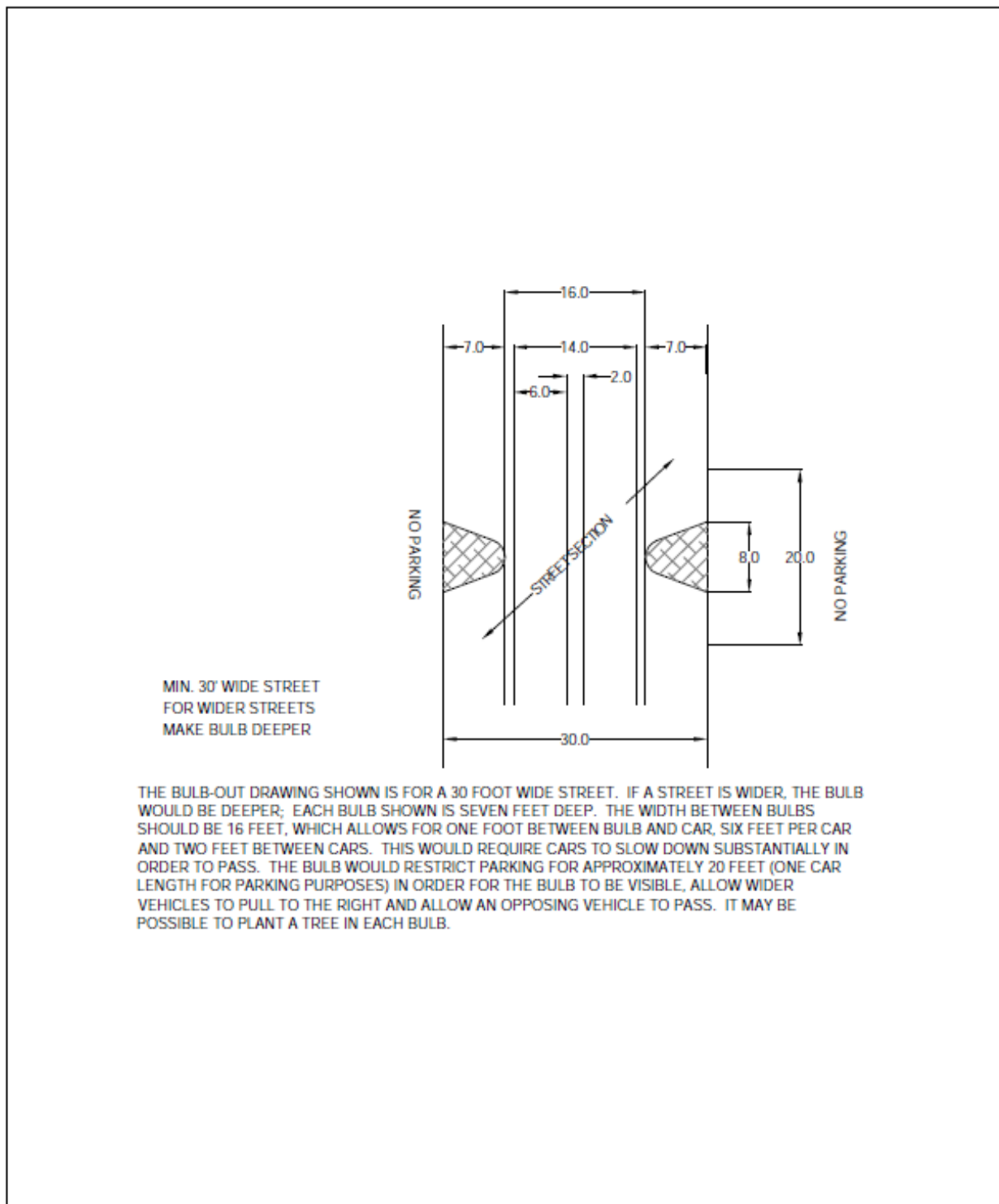
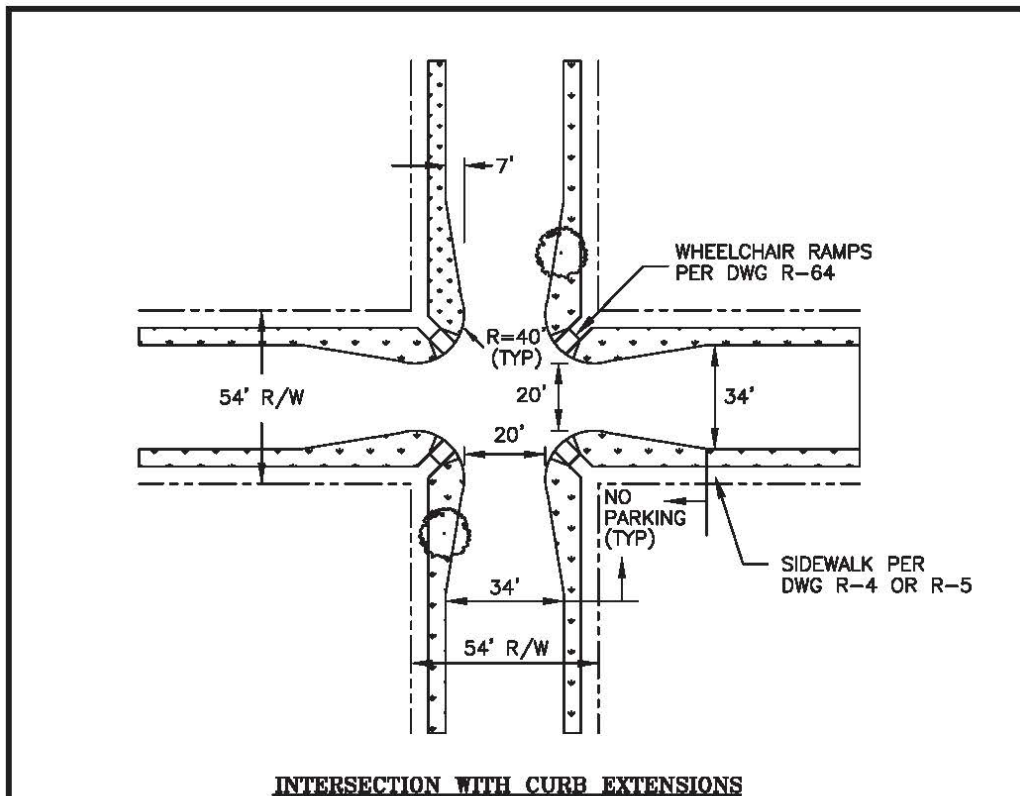

Figure A-6: Bulbout (Intersection Treatment)



**NOTES:**

1. CURB EXTENSIONS (BULB-OUTS) MAY BE INSTALLED TO REDUCE PEDESTRIAN CROSSING DISTANCES AT INTERSECTIONS, SUBJECT TO THE APPROVAL OF THE CITY ENGINEER.
2. CURB EXTENSIONS SHALL NOT IMPEDE THE MOVEMENT OF EMERGENCY VEHICLES OR GARBAGE TRUCKS. AN ENGINEERING ANALYSIS OF VEHICLE TURNING MOVEMENTS SHALL BE PREPARED.
3. WHERE A LOCAL STREET INTERSECTS A COLLECTOR OR ARTERIAL STREET, THE DESIGN AND PLACEMENT OF CURB EXTENSIONS SHALL NOT RESULT IN SIGNIFICANT IMPACTS TO TRAFFIC CIRCULATION ON THE COLLECTOR OR ARTERIAL STREET, AS DETERMINED BY THE CITY ENGINEER.
4. CURB EXTENSIONS SHALL NOT REDUCE THE EFFECTIVE WIDTH OF A LOCAL STREET TO LESS THAN 20 FEET AT ANY POINT.
5. INTERSECTION DESIGN SHALL BE APPROVED BY THE CITY ENGINEER.
6. CURB EXTENSIONS SHALL BE ALLOWED ON STREETS WITH MEDIANS.
7. THERE SHALL BE NO DRIVEWAYS WITHIN THE EXTENSION AREA.

<b>LOCAL STREET RESIDENTIAL INTERSECTION CURB EXTENSIONS</b>	REVISION NO. 1	APPROVED BY CITY ENGINEER:  DATE: 09/27/2016	
	 CITY OF STOCKTON DEPARTMENT OF PUBLIC WORKS	SCALE NONE	SUPERSEDES DWG. DATED 11/25/03

Figure A-7: Center Island Narrowing

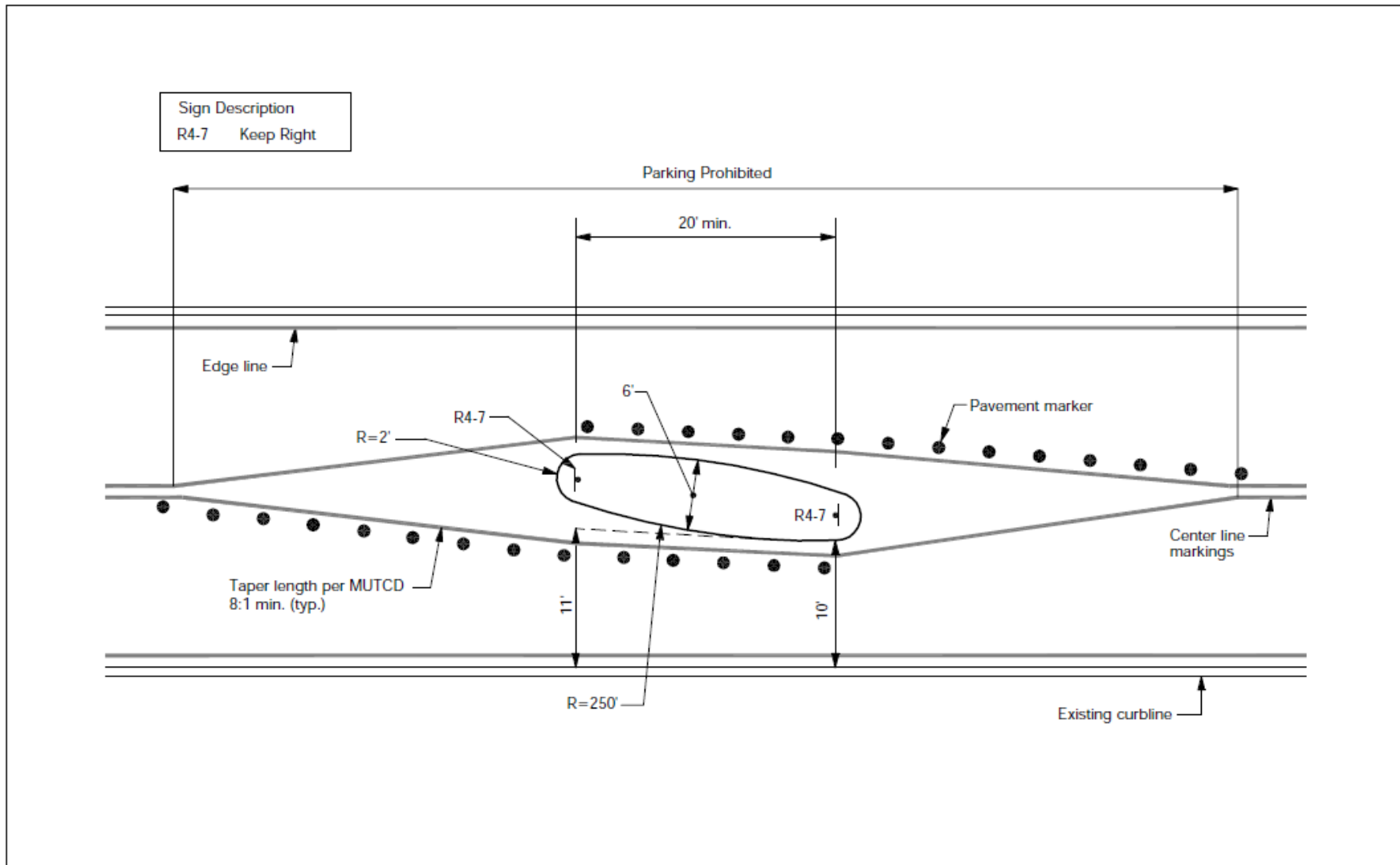

Figure A-8: Choker

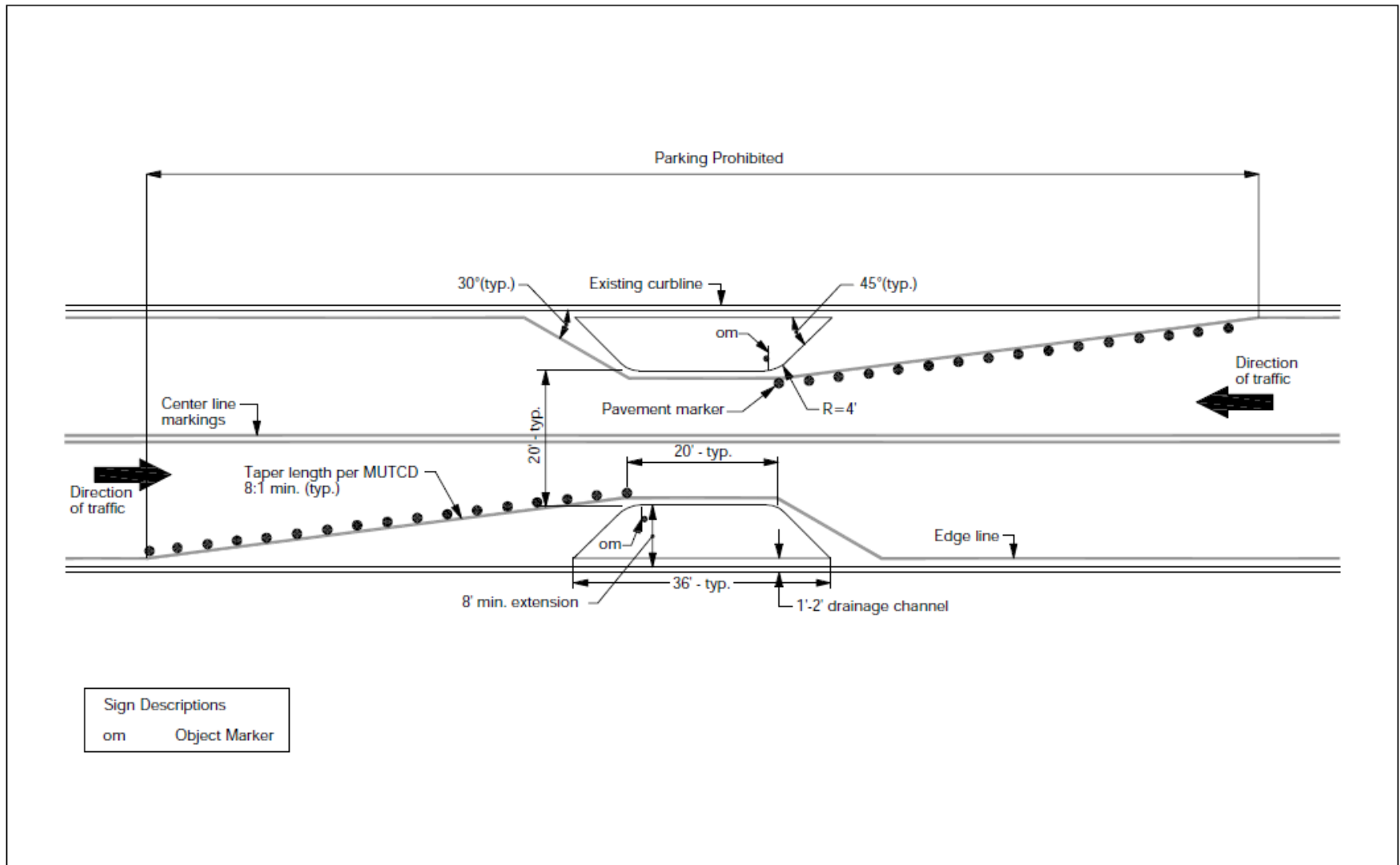

Figure A-9: Speed Hump

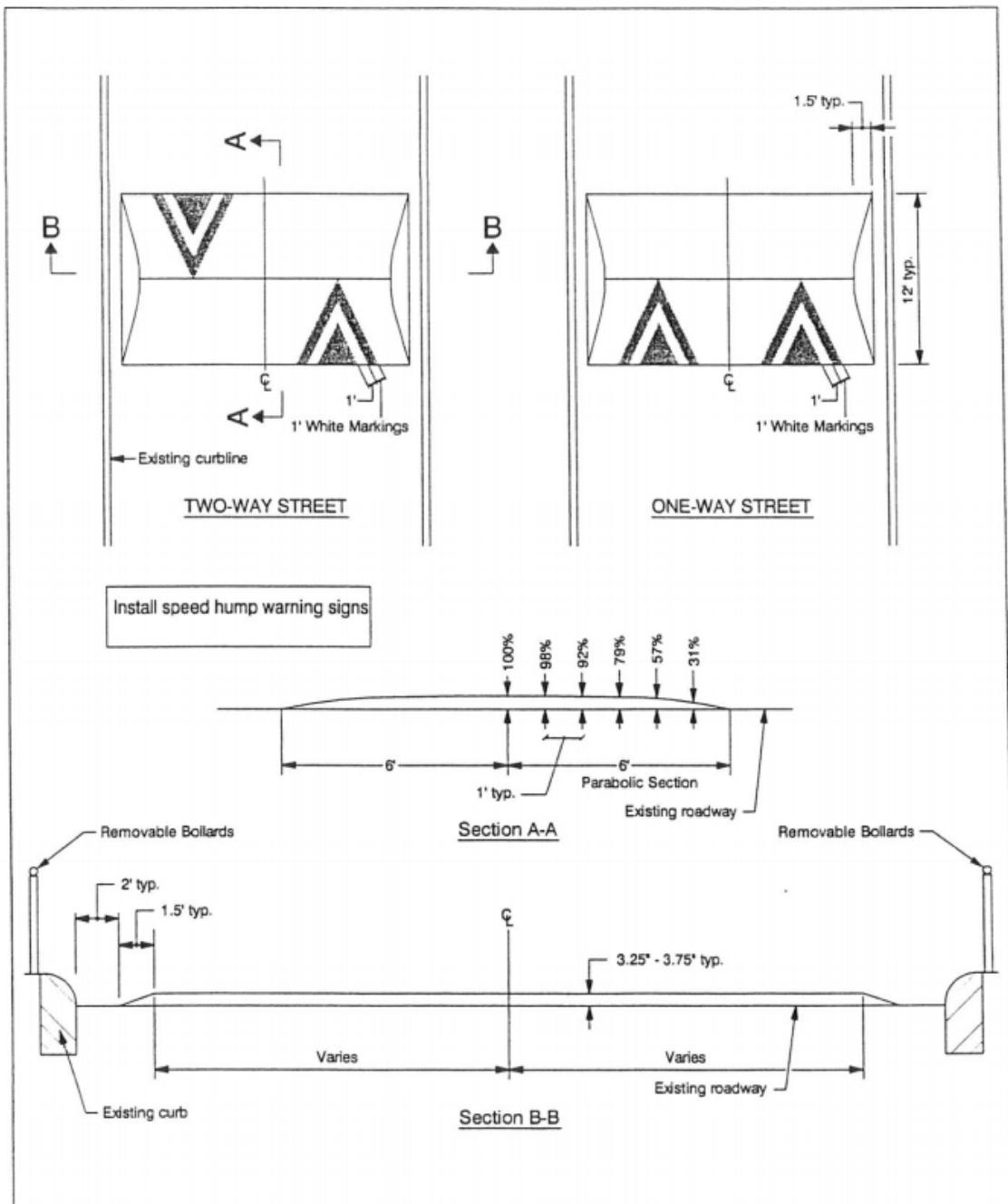
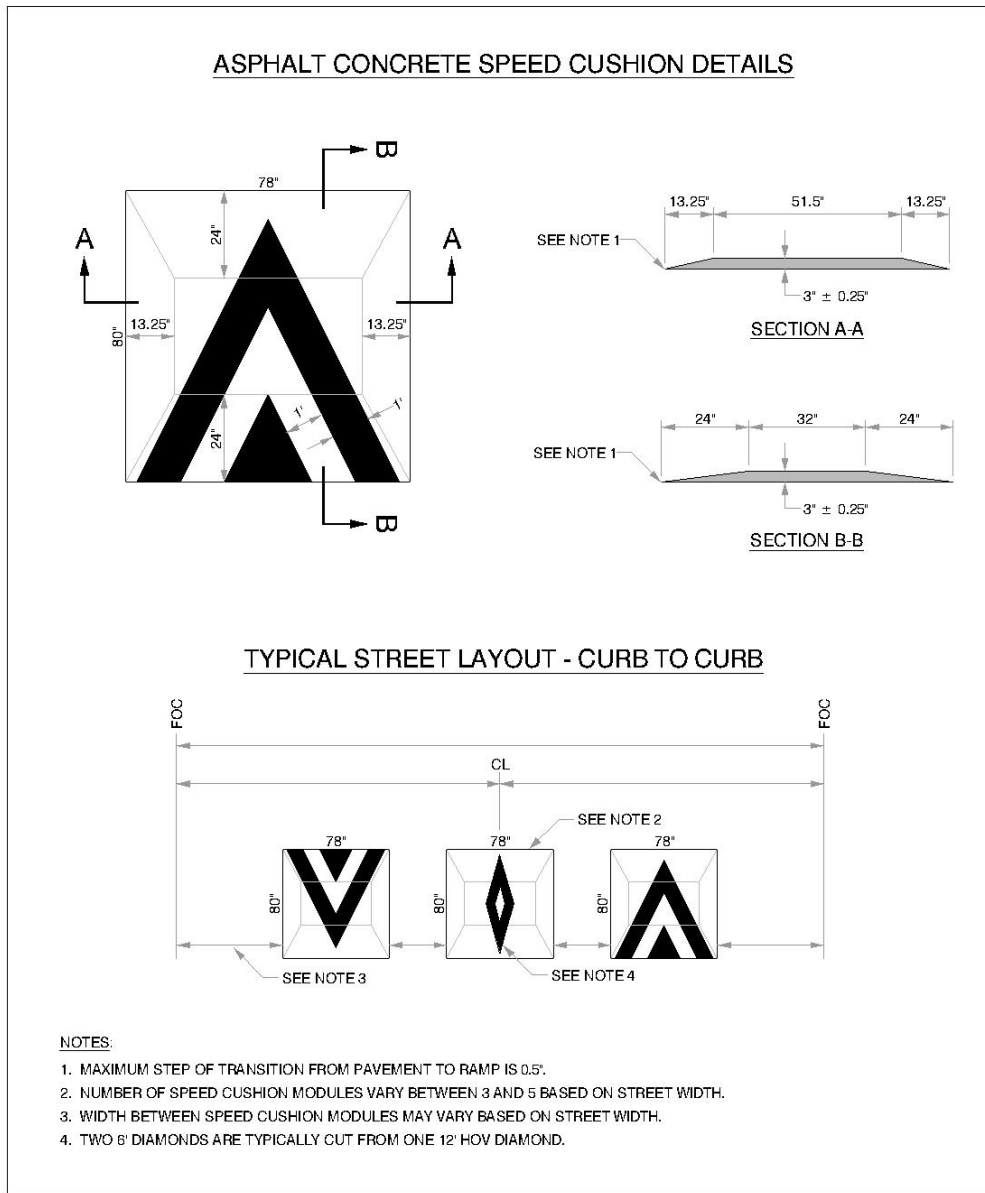



Figure A-10: Speed Cushion



STREET LAYOUT NOT TO SCALE

**3 SPEED CUSHION**  
Template

Figure A-11: Speed Table

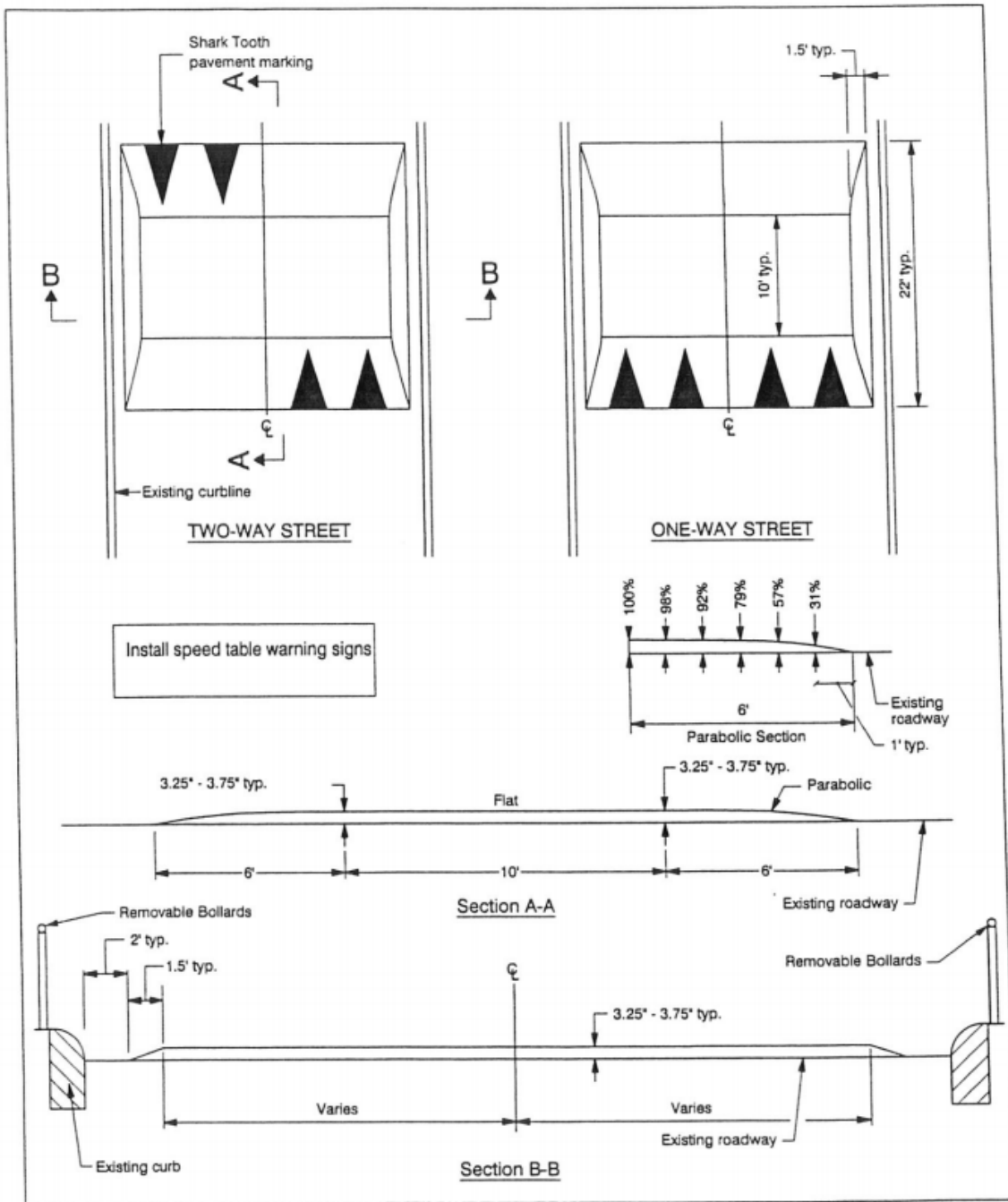

Figure A-12: Raised Crosswalk

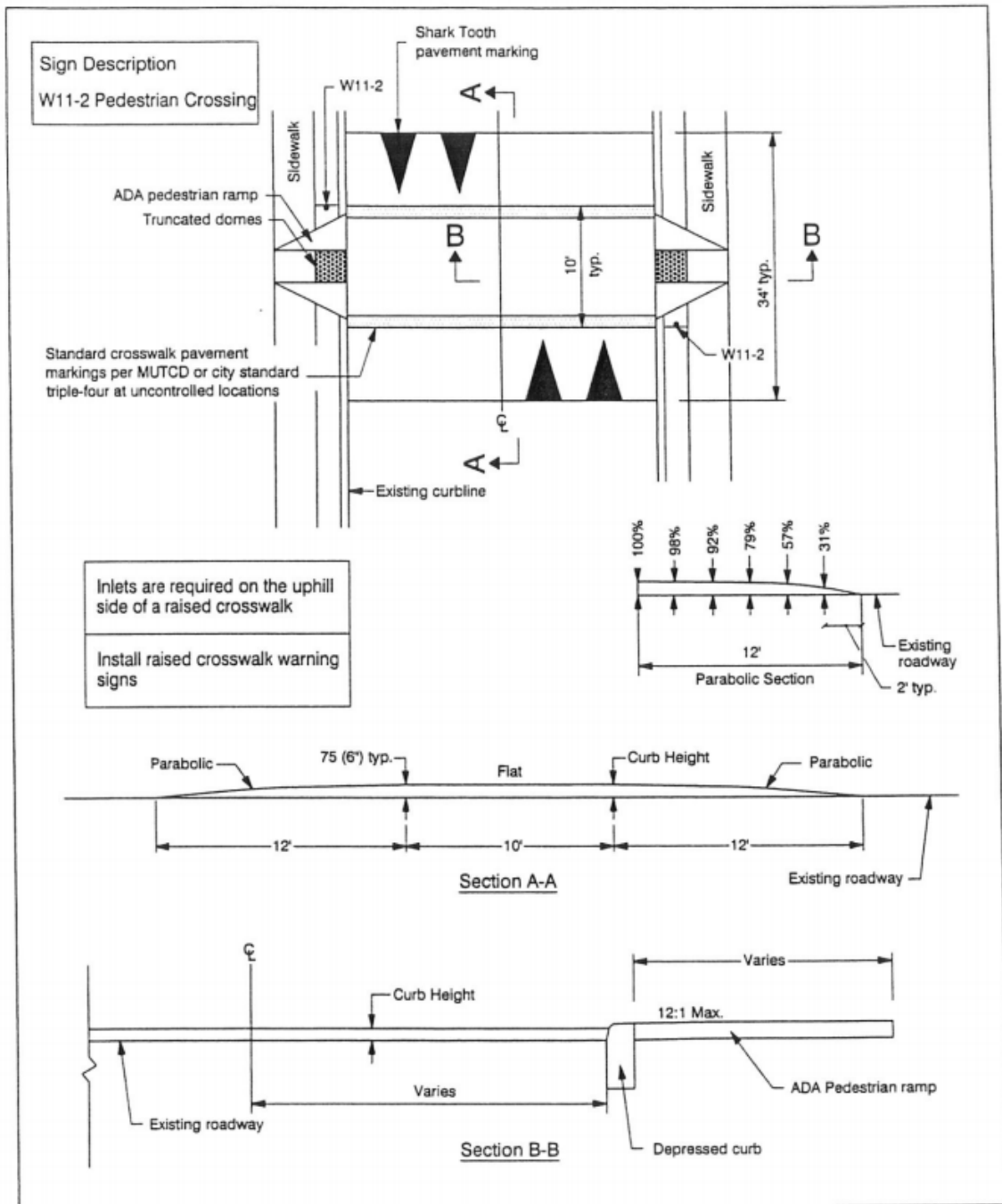

Figure A-13: Raised Intersection

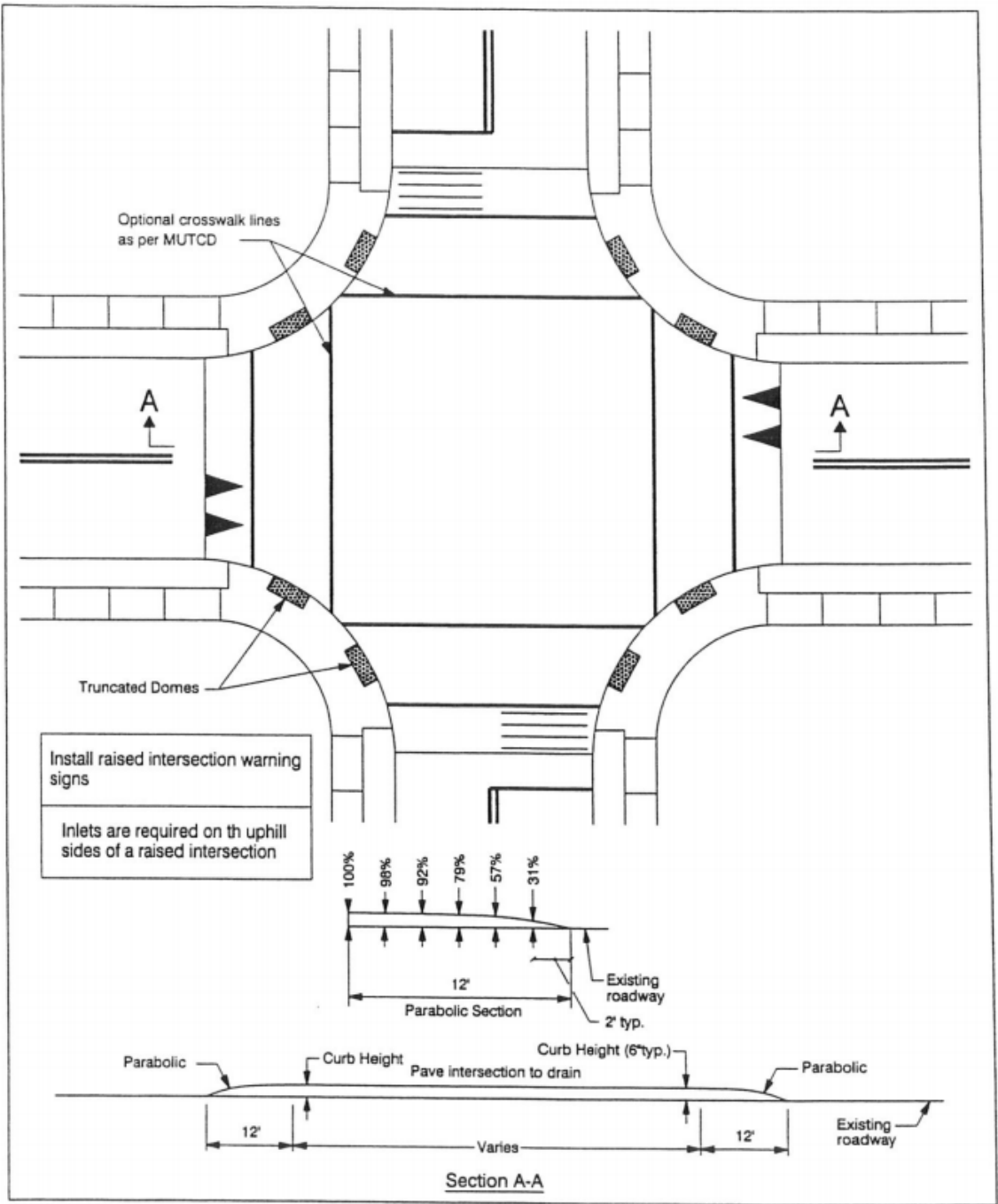

Figure A-14: Half Closure

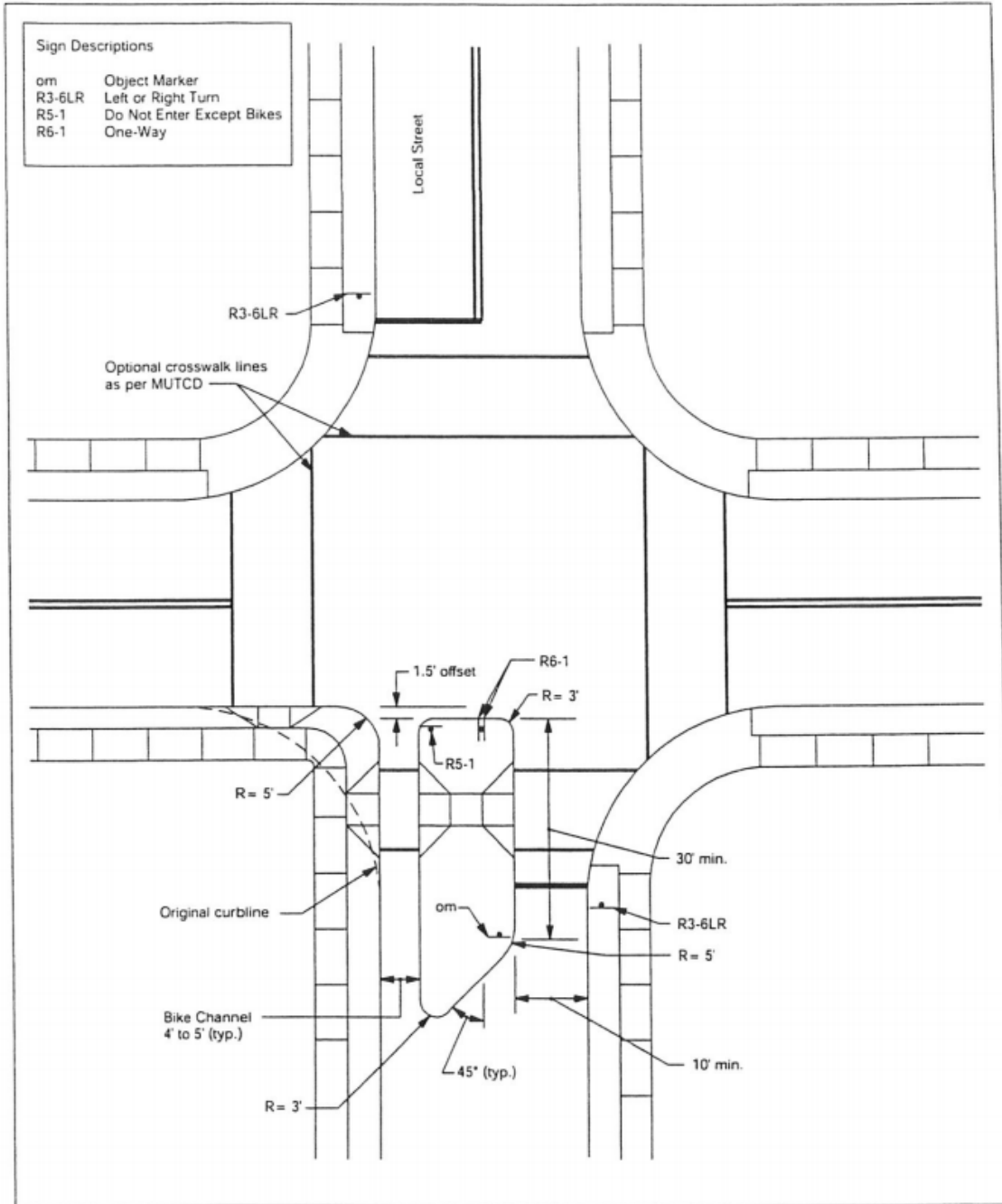

Figure A-15: Median Barrier

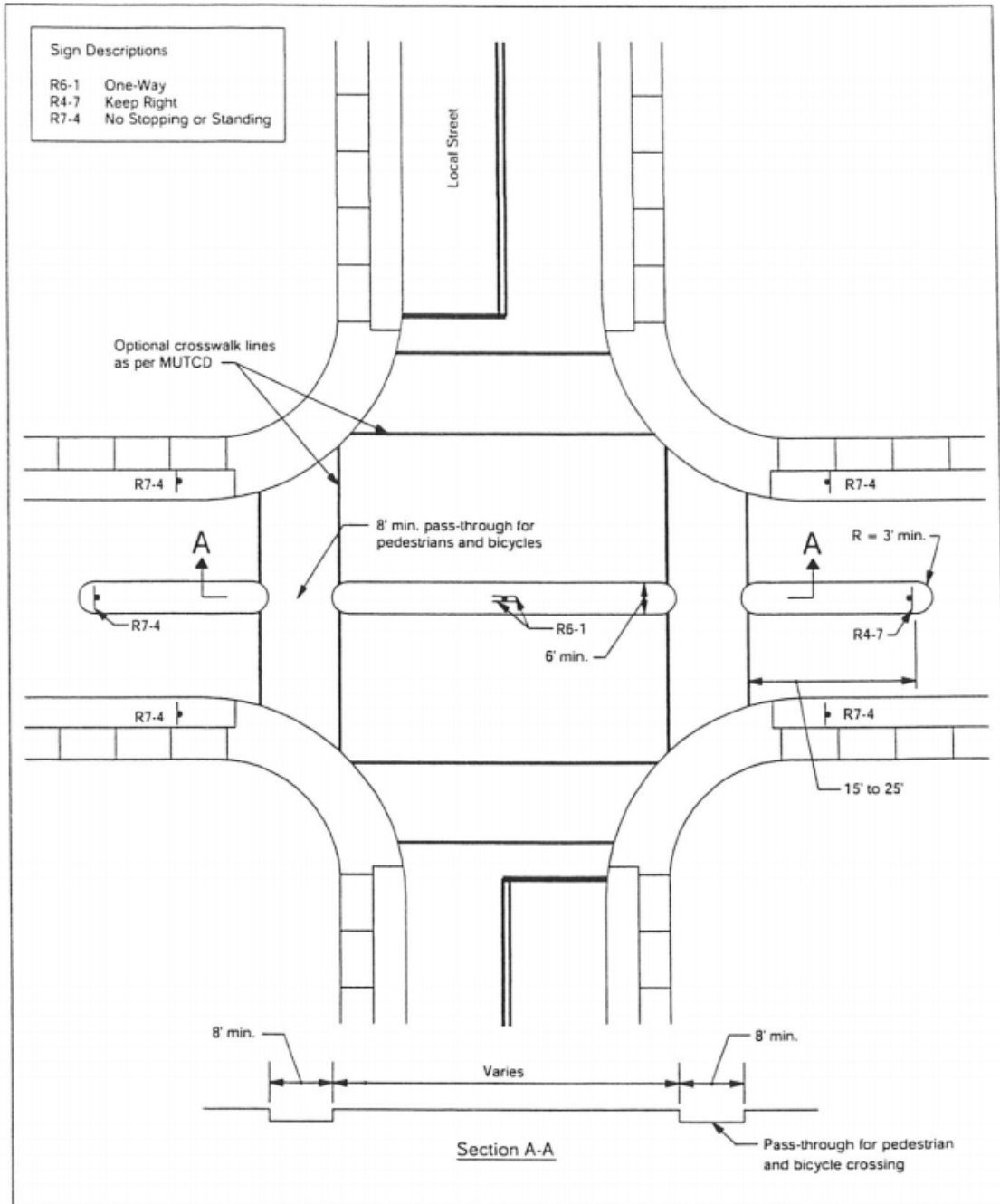

Figure A-16: Forced Turn Island

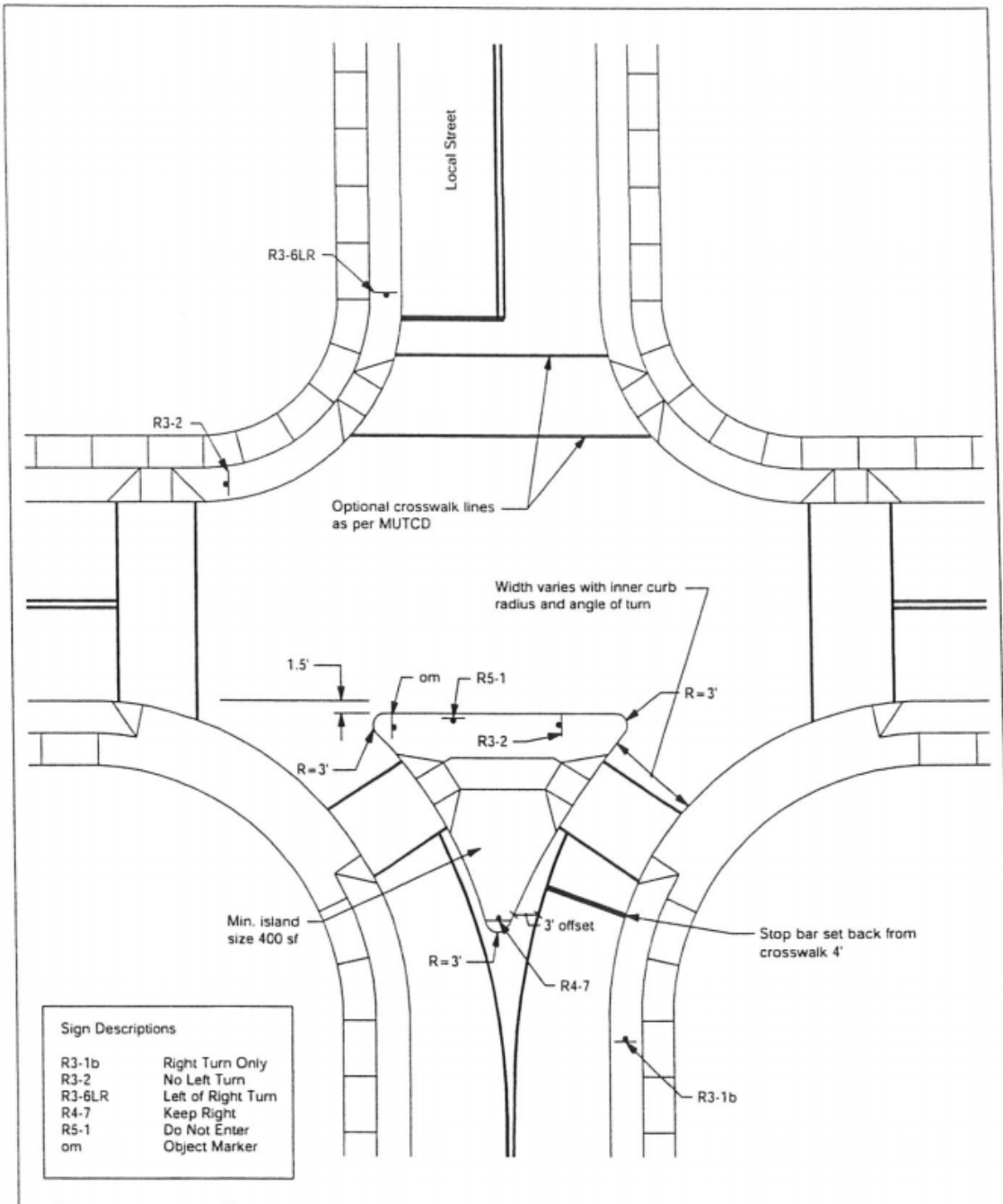

Figure A-17: Warning Signs

W17-1

Issued 3/1/2012





STATE OF CALIFORNIA - DEPARTMENT OF TRANSPORTATION

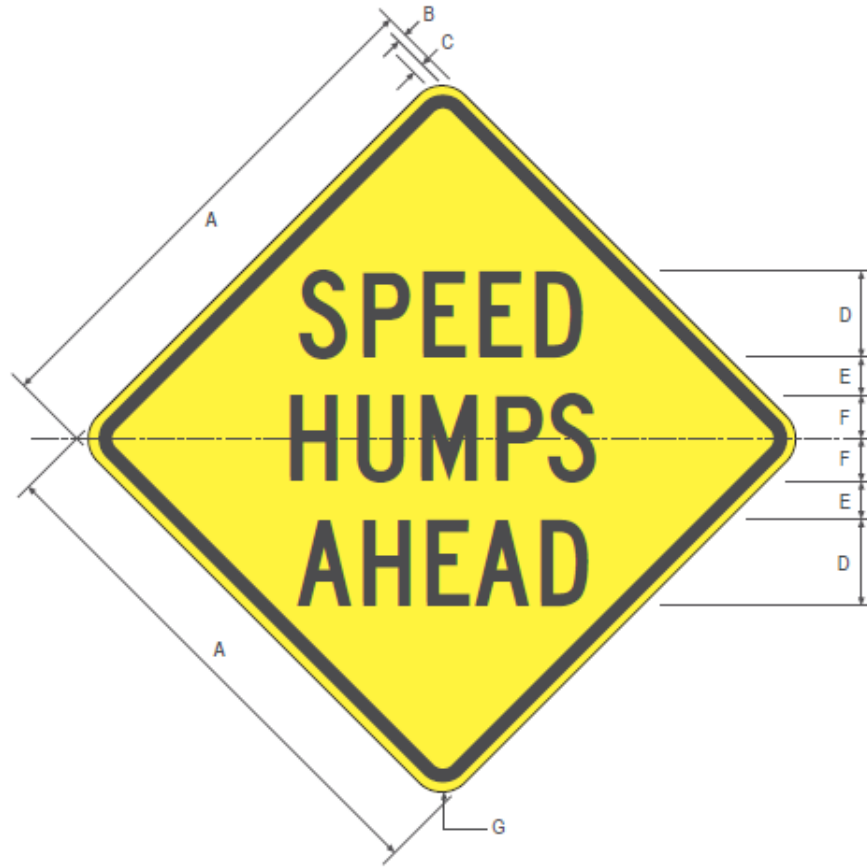

W84 (CA)

ENGLISH UNITS

A	B	C	D	E	F	G
30	.625	.875	4C	2	2	2
36	.625	.875	6C	3	3	2.25

COLORS: BORDER & LEGEND - BLACK  
 BACKGROUND - FLUORESCENT YELLOW (RETROREFLECTIVE)

ALT TEXT: SPEED BUMPS AHEAD

11/07/2014

STATE OF CALIFORNIA - DEPARTMENT OF TRANSPORTATION

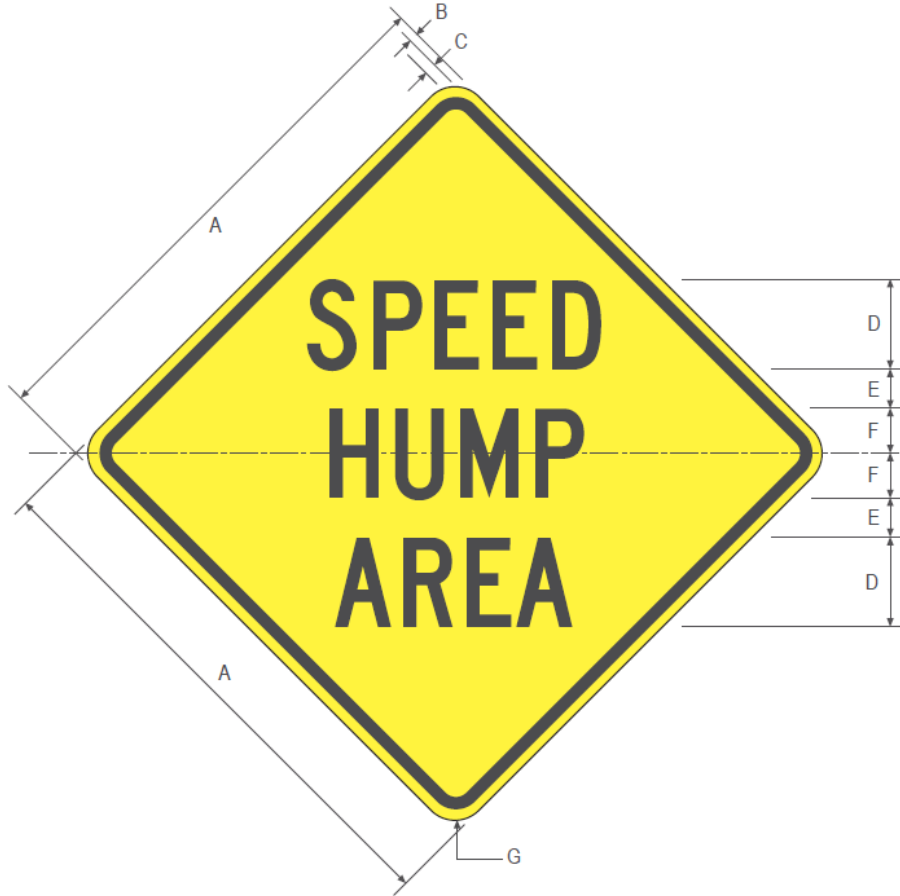

W85 (CA)

ENGLISH UNITS

A	B	C	D	E	F	G
30	.625	.875	4C	2	2	2
36	.625	.875	6C	3	3	2.25

COLORS: BORDER & LEGEND - BLACK  
 BACKGROUND - FLUORESCENT YELLOW (RETROREFLECTIVE)

ALT TEXT: SPEED BUMP AREA

11/07/2014

# Appendix B:

## Checking Roundabout Compatibility

When considering a roundabout for a particular intersection, the expected traffic volumes and the available geometry must be taken into consideration, along with several other considerations.

### Traffic Volumes

The first check is to determine whether a roundabout could accommodate the traffic volumes at a particular intersection. Two quantities are required: the Maximum Entry Flow and the Maximum Circulatory Flow (see Figure B-1). The Maximum Entry Flow is the traffic volume entering the intersection (including left-turning, through, and right-turning vehicles) at the highest-volume approach. Circulatory Flow is calculated for each quadrant of the circulating lane by adding up the contributing Entry Flows:

$$V_{EB,circ} = V_{WB,LT} + V_{SB,LT} + V_{SB,TH} + V_{NB,U-turn} + V_{WB,U-turn} + V_{SB,U-turn}$$

$$V_{WB,circ} = V_{EB,LT} + V_{NB,LT} + V_{NB,TH} + V_{SB,U-turn} + V_{EB,U-turn} + V_{NB,U-turn}$$

$$V_{NB,circ} = V_{SB,LT} + V_{EB,LT} + V_{EB,TH} + V_{WB,U-turn} + V_{SB,U-turn} + V_{EB,U-turn}$$

$$V_{SB,circ} = V_{NB,LT} + V_{WB,LT} + V_{WB,TH} + V_{EB,U-turn} + V_{NB,U-turn} + V_{WB,U-turn}$$

where  $V_{i,circ}$  = Circulatory flow immediately downstream of approach  $i$ .

$V_{ij}$  = Traffic volume at approach  $i$  taking turning movement  $j$ ;

$EB, WB, NB, SB$  = Eastbound, Westbound, Northbound, and Southbound, respectively;

and  $LT, TH, U-turn$  = Left Turn, Through, and U-Turn, respectively.

After using the above formula to find the circulatory flows, the highest of the four values is used in Figure B-1 in combination with the Maximum Entry Flow to determine whether an Urban Single-Lane Roundabout could accommodate the traffic volume.

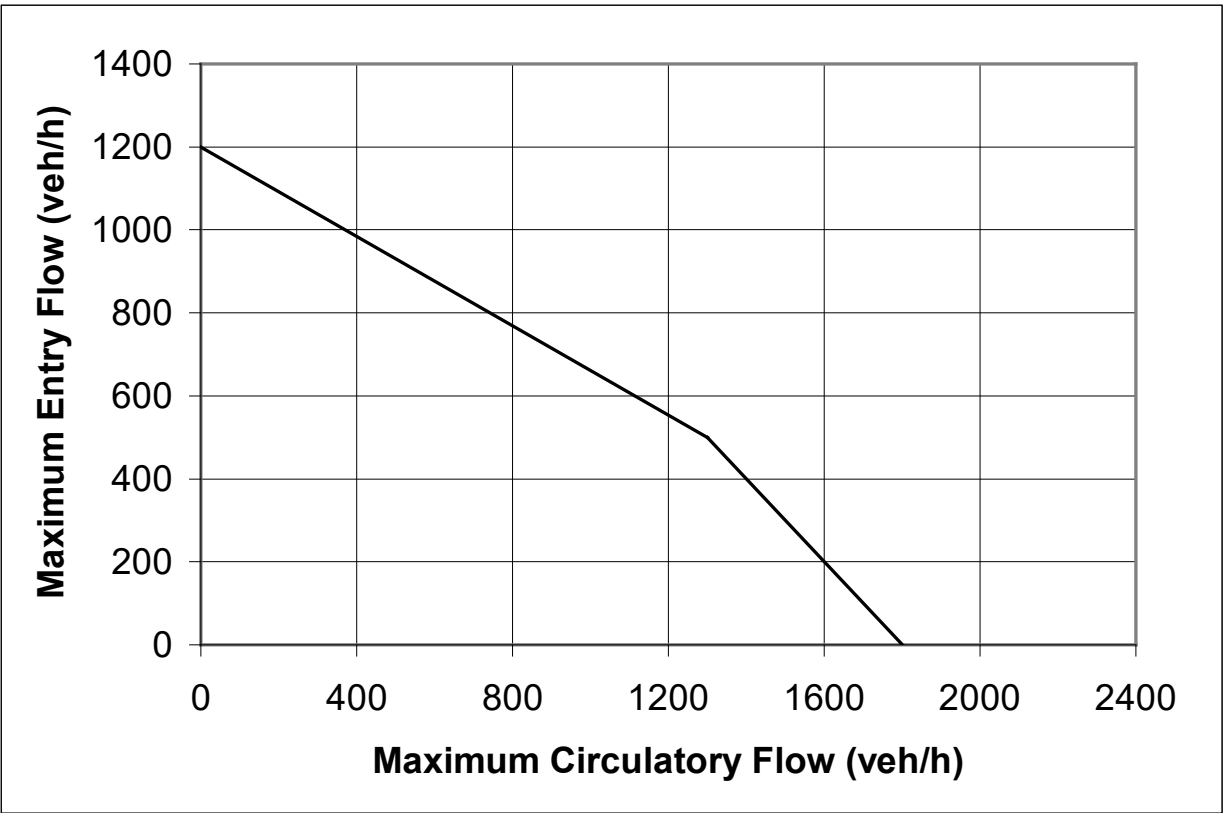

*Figure B-1. Approach Capacity of an Urban Single-Lane Roundabout*

**Geometry**

The second check is the available geometry. The width of the approach tapers and the size of the inscribed diameter of a roundabout can vary over a wide range. However, it may be possible to eliminate a roundabout from consideration by comparing the available right-of-way to some minimum geometric values as shown in Drawing 12B of the Standard Plans.